

DATA SHEET



USB-C 2.0 Male to Male Cable (5A)

Connect any two standard USB-C enabled devices to simultaneously charge and transfer data

OVERVIEW

The USB-C to C 2.0 Male to Male Cable is the perfect solution for connecting two standard USB-C enabled devices or accessories for charging and data transfer.

Ensure that a USB-C equipped laptop, smartphone, or tablet is fully charged and ready to go with the 3A charging output, while simultaneously transferring photos, music, or data at speeds up to 480 Mbps.

The USB-C connector has a symmetrical design which is identical on both sides, so no more worrying about whether it's upside-down or right-side-up. It will plug in the first time, every time—while preventing damage to the connector port.

FEATURES

- Longer transfer distance than USB 3.1 Gen 2 cables
- 5A charging output
- Data transfer speeds up to 480 Mbps
- Reversible, symmetrical USB-C connector

ITEM DESCRIPTION

28829 10ft USB-C 2.0 Male to Male Cable (5A)

DATA SHEET

SPECIFICATIONS: USB-C 2.0 Male to Male Cable (5A)

ELECTRICAL SPECIFICATIONS:

- NO—UL 24AWG (26/0.10TC)*4C+[28AWG(7/0.127TC)*1P+AL]+30AWG (7/0.1TC)*2C+4E(26/0.1TC)+AB(16/9/0.10TC 85%TC)OD:4.5mm ~ Black
- Rated Temperature: 80°C ; Voltage: 30 V
- Max Conductor Resistance at 20°C: 30AWG , 378 OHMS/KM
- Insulation Resistance: 10M-KM MIN at 20°C DC 500V.(EIA—364—21)
- Dielectric Strength: AC 500V/1 Minute No Breakdown.(EIA—364—20)

PHYSICAL SPECIFICATIONS:

- Operating Temperature: 0 ~ 50°C; 15-85% RH (Non-Condensing)
- Storage Temperature: -25 ~ 70°C; 15-85% RH (Non-Connectng)
- P1: USB3.1 C Type Male: Contacts Terminal Gold Flash, Nickel Plated Shell; Black Insulation
- P2: USB3.1 C Type Male: Contacts Terminal Gold Flash, Nickel Plated Shell; Black Insulation
- Molding Material: Black PVC Conform RoHS
- Product is CE marked and conforms to 2011/65/EU RoHS2

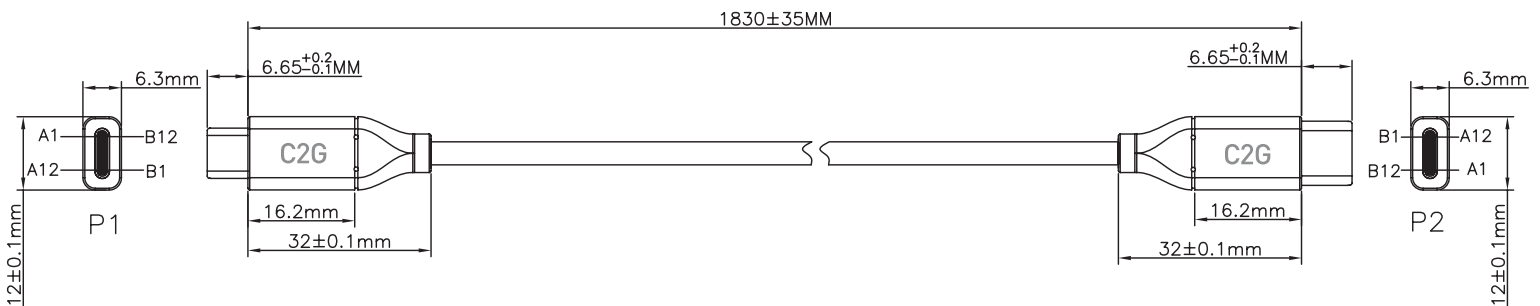

CABLE Cross Section.:

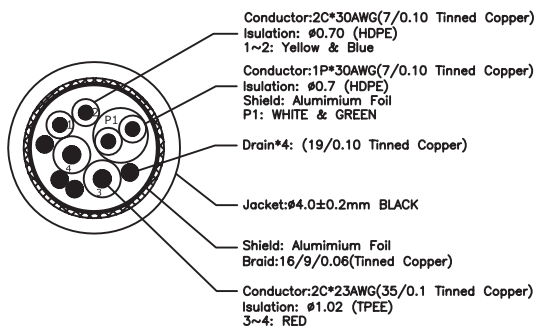

Pin Assignment

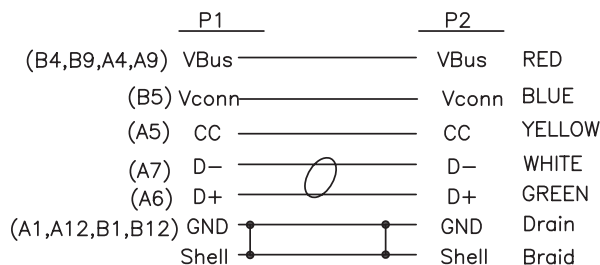

C2G
A brand of **legrand**

3555 Kettering Blvd.
Moraine, OH 45439
Phone: 800.CABL.911
www.c2g.com

Follow Us

