

# RMX 100 Rack Shelf

## Installation Guide

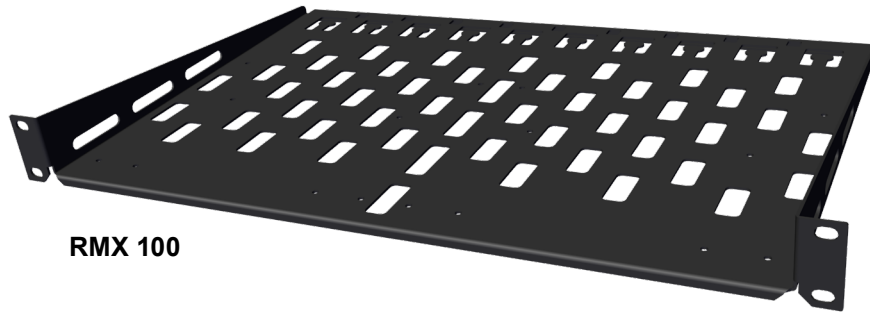

RMX 100

### Representative configurations



RMX 100 with TesiraFORTÉ X and Devio SCX



RMX 100 with TesiraFORTÉ X and TesiraCONNECT

## PRODUCT DESCRIPTION

The RMX 100 is specially tailored to mount two TesiraFORTÉ X, Devio SCX and/or TesiraCONNECT devices side by side in a typical rack (1RU).

## CONTENTS

Hardware, etc

Qty	Size / Type	Use
8	M3 x 10	Phillips Screw - Device attachment
8	M3	Flat Washer - Device attachment
8	M3	Lock Washer - Device attachment
4	#10-32 x .75"	Rack Screw - Rack attachment
4	#12-24 x .75"	Rack Screw - Rack attachment
4	M6 x .75"	Rack Screw - Rack attachment
25	Cable ties	Cable organization

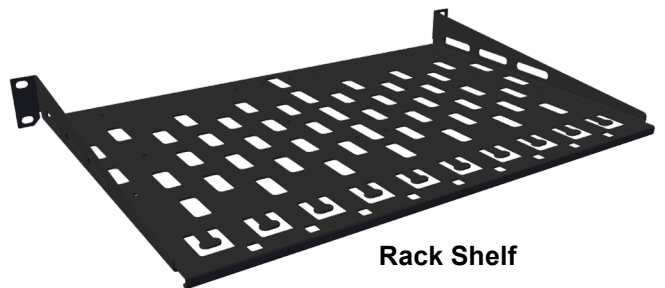

Rack Shelf

# INSTALLATION

## Configurations

One or two devices can be mounted to the rack shelf. See at right for applicable configurations. Mount the devices to the shelf before installing it in the rack.

Do **NOT** place a TesiraCONNECT to the left of either a TesiraFORTÉ X or Devio SCX.

Ambient Operating Temperature:  
32-104° F (0-40° C)

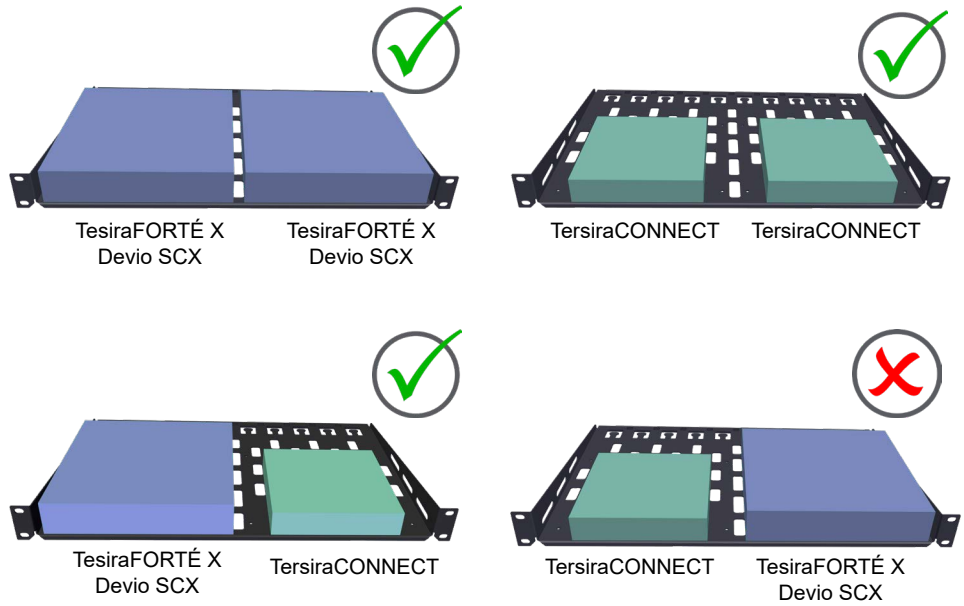

## Before assembly

If the device comes attached to a wall mount bracket, remove the bracket before attaching it to the shelf.

1. Review the attachment holes for each type of device.

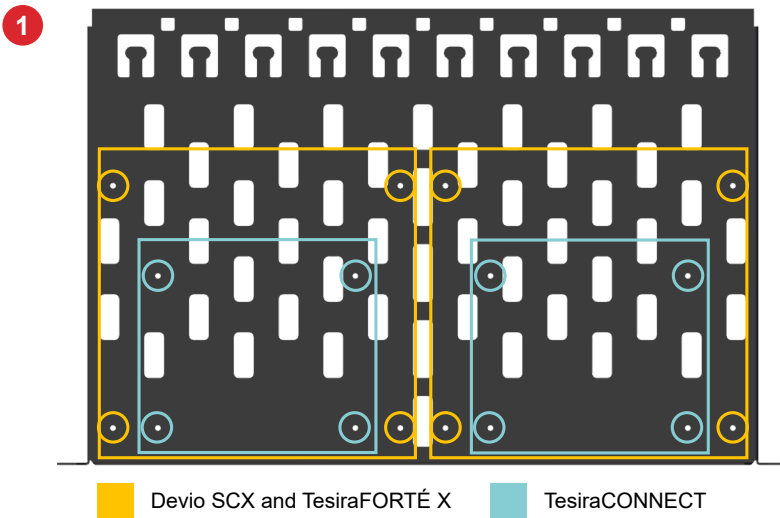

2. Place the devices upside down on a protected surface and remove the rubber feet on the bottom of each device.



## Installation (continued)

- Place the shelf on top, align the appropriate hole pattern and screw the rack shelf to the device using lock washers and flat washers with the M3 screws.



- Install the rack shelf using the hardware that matches the rail threads (*hardware provided*), and make connections to the devices per their installation guide.

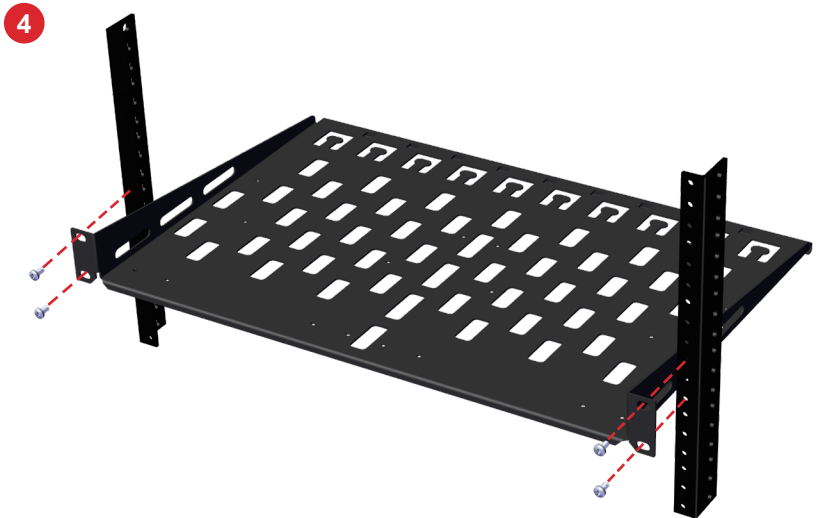

- Use the cable ties to manage the cables coming from the devices. Cables can also be routed along the back of the shelf by using the holes along the edge of the shelf (see example below).

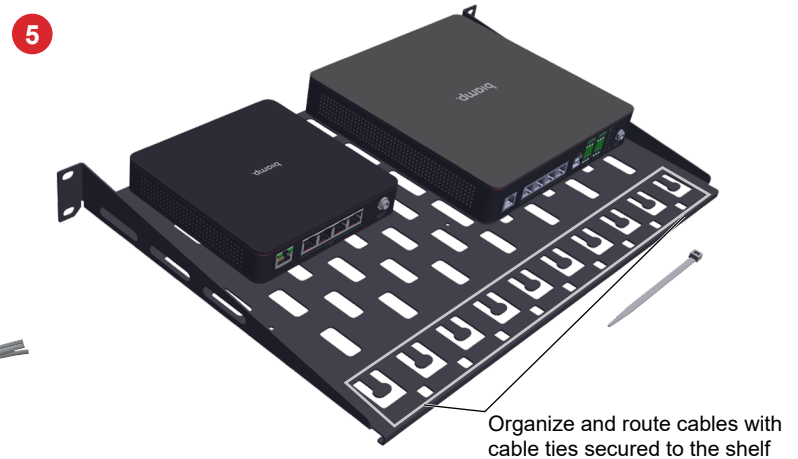
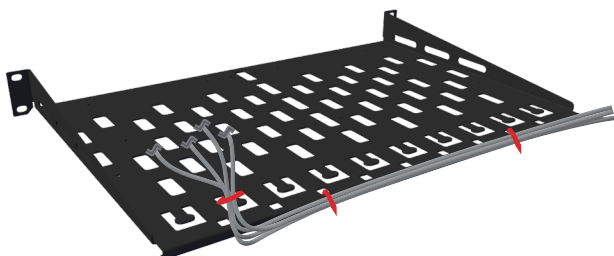

## CONTACT US

Email: [support@biamp.com](mailto:support@biamp.com) Warranty: [biamp.com/legal/warranty-information](https://www.biamp.com/legal/warranty-information)

Web: [support.biamp.com](https://support.biamp.com) Safety & Compliance: [biamp.com/compliance](https://www.biamp.com/compliance)



A: 9300 S.W. Gemini Drive Beaverton, OR 97008 USA

W: [www.biamp.com](https://www.biamp.com)

20APR2022