



Hall Technologies • 1234 Lakeshore Dr Suite #150 Coppell, TX 75019 • halltechav.com

# HT-CAM-1080PTZ

Full HD PTZ Camera

## USER MANUAL

January 23, 2023



# Important Safety Instructions



1. Do not expose this apparatus to rain, moisture, dripping or splashing and that no objects filled with liquids, such as vases, shall be placed on the apparatus.



2. Do not install or place this unit in a bookcase, built-in cabinet or in another confined space. Ensure the unit is well ventilated.



3. To prevent risk of electric shock or fire hazard due to overheating, do not obstruct the unit's ventilation openings with newspapers, tablecloths, curtains, and similar items.



4. Do not install near any heat sources such as radiators, heat registers, stoves, or other apparatus (including amplifiers) that produce heat.



5. Do not place sources of naked flames, such as lighted candles, on the unit.



6. Clean this apparatus only with dry cloth.



7. Unplug this apparatus during lightning storms or when unused for long periods of time.

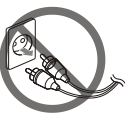

8. Protect the power cord from being walked on or pinched particularly at plugs.



9. Only use attachments / accessories specified by the manufacturer.



10. Refer all servicing to qualified service personnel.

# Table of Contents

<b>Introduction</b> _____	<b>4</b>	<b>Web UI</b> _____	<b>23</b>
Overview		Preview	
Features		Monocular Tracking	
<b>Package Contents</b> _____	<b>5</b>	<b>Configuration: audio</b>	
<b>Product Views</b> _____	<b>6</b>	Configuration: video configure / video encode	
Front View		<b>Configuration: video configure / stream publish</b>	
Rear View		<b>Configuration: video configure / rtp multicast</b>	
Dimensions View		Configuration: video configure / video parameters / focus	
<b>Rotary Dial</b> _____	<b>7</b>	Configuration: video configure / video parameters / style	
<b>Connectors &amp; Indicator</b> _____	<b>9</b>	Configuration: video config/video parameters/exposure	
RS-232 INTERFACE		Configuration: video configure / video parameters / color	
RS-232 MINI-DIN 8-PIN		Configuration: video config / video parameters / image	
RS-232 (DB9)		Configuration: video configure / video parameters / nr	
<b>Setup</b> _____	<b>10</b>	Configuration: video configure / video osd	
Installation		<b>Configuration: video configure / osd font size</b>	
Step one		Configuration: video configure / video out	
Step two		Configuration: network configure / network port	
Step three		Configuration: network configure / ethernet	
Step four		Configuration: network configure / dns	
<b>Application Wiring</b> _____	<b>11</b>	Configuration: network configure / srt	
Scenario A : USB-B Output		Configuration: network configure / rtsp	
Scenario B : HDMI & HD-SDI Outputs		Configuration: system configure / system attribute	
Scenario C : Streaming		Configuration: system configure / system time	
<b>Control – IR Remote Control</b> _____	<b>13</b>	Configuration: system configure / user set	
Key Combinations		Configuration: system configure / update	
<b>OSD Menu</b> _____	<b>15</b>	Configuration: system configure / default	
Main Menu		Configuration: system configure / reboot	
Monocular Tracking		<b>Soft Codec Support</b> _____	<b>45</b>
Setup		Google Meet	
Camera		Microsoft teams	
Camera - exposure		Zoom	
Camera - color		Video	
Camera - image		<b>Troubleshooting</b> _____	<b>48</b>
Camera - focus		No Image	
Camera - noise reduction		Abnormal Image	
PTZ		Shaky or Vibrating Image	
Video - format		No Video in Soft Codec	
Version		<b>Specifications</b> _____	<b>49</b>
Restore Default			

# Introduction

---

## OVERVIEW

The HT-CAM-1080PTZ is an HD PTZ camera. With built-in AI intelligence, the camera can automatically pan, tilt, and/or zoom to the best view to include all participants or track a presenter, and regions can be set in the view to prevent the camera from tracking undesired areas. And, built around a low noise CMOS image sensor, the lens provides for a clean and clear video even in low lit areas.

The HT-CAM-1080PTZ includes multiple output options including HDMI, 3G-SDI, USB3.0, and LAN, with simultaneous sub streams. When used as the main or sub stream, the USB3.0 output supports multiple audio/video compression standards and multiple soft codec applications such as Google Meet, Microsoft Teams, and Zoom.

With a height of just over 7" the camera's small form factor allows for it to be installed in any room without being obtrusive. The camera can be fixed to a tripod, installed on the wall using the included wall mount, or installed to the ceiling (ceiling mount sold separately).

## FEATURES

- Multiple video output interfaces including HDMI, SDI, USB 3.0, LAN
- Full HD Resolution up to 1920x1080@60fps
- Up to 12x optical zoom and 15x digital zoom
- 1/2.8 inch high quality CMOS image sensor
- Auto Framing with superior face detection to automatically frame the view according to the number of people in the room
- Supports multiple audio/video compression standards, including H.264/H.265 video compression and AAC, MP3 and G.711A audio compression
- USB 3.0 dual coding stream adding a simultaneous output for YUY2, MJPEG, H.264, NV12, H.265 video coding
- Low noise CMOS with advanced 2D/3D noise reduction technology providing for a high signal-to-noise ratio for clean and clear video even in low-lit areas
- Built-in high accuracy step driving motor for quiet and smooth pan and tilt movement
- Supports multiple applications such as personal video conferencing, collaboration meetings, enterprise video conferencing, etc.
- Supports multiple soft codec applications such as Google Meet, Microsoft Teams, and Zoom.

## Package Contents

---

- 1x 1080p PTZ Camera
- 1x USB 3.0 Type-B to Type-A Cable, 3m (9.8ft)
- 1x 9-pin Female D-Sub to 8-pin Male mini-DIN cable
- 1x IR Remote Control
- 1x Power Adapter
- 1x Wall Mount

# Product Views

**FRONT VIEW**



**REAR VIEW**



**DIMENSIONS VIEW**

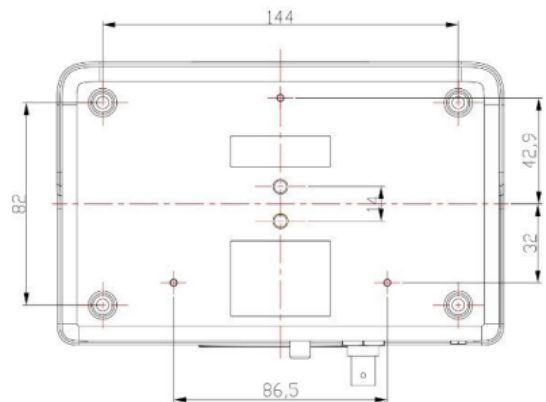
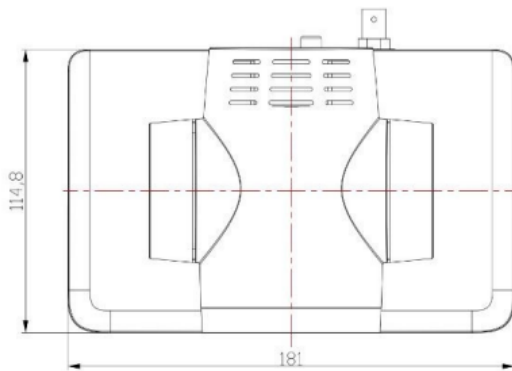
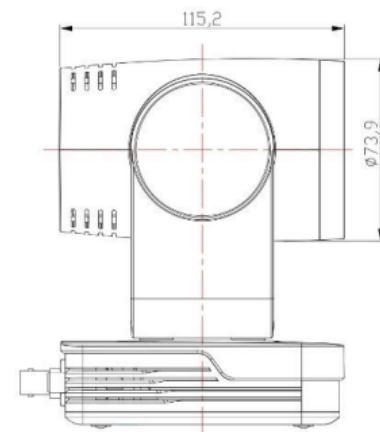
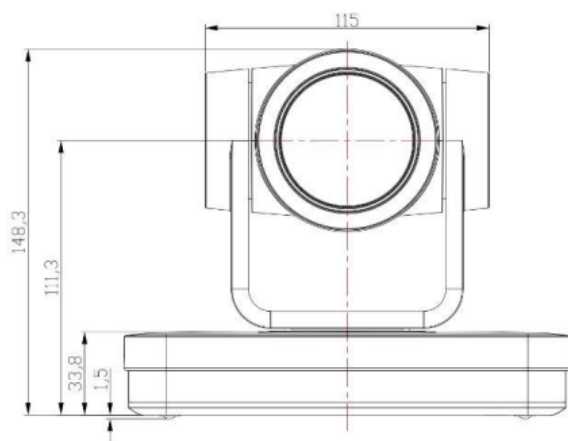

# Connectors & Indicators

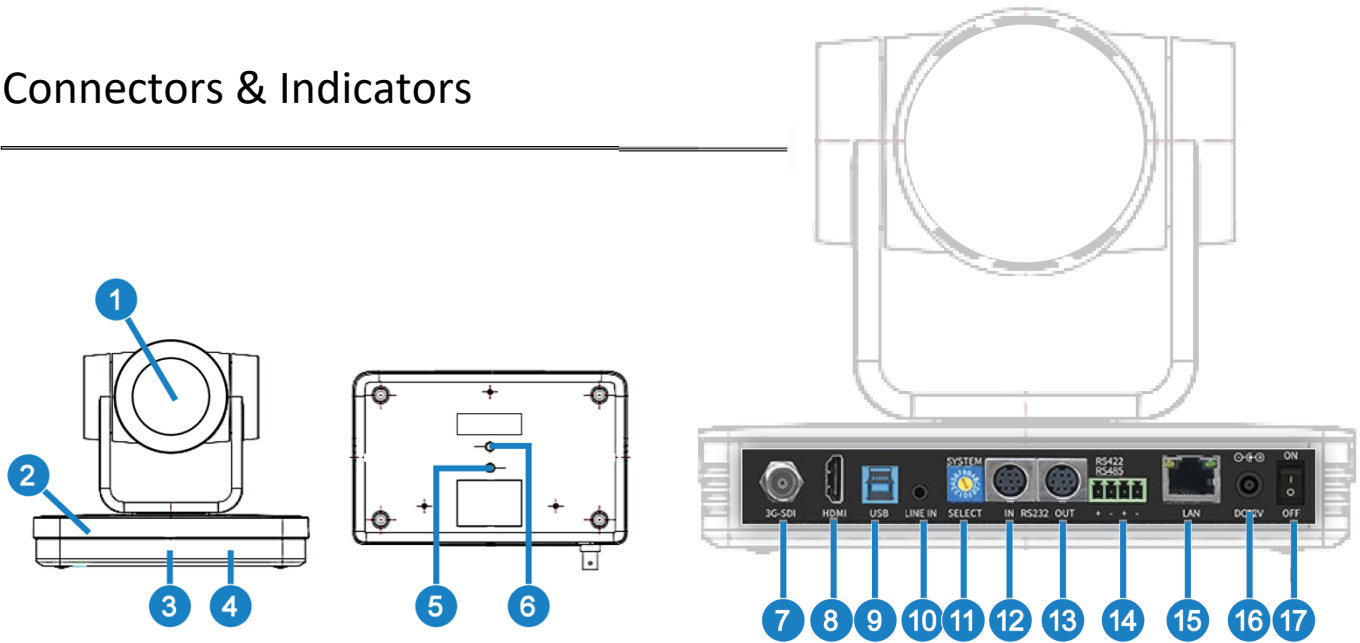

No.	Name	Description
1	Camera Lens	Camera Lens
2	Camera Base	Base of the PTZ Camera
3	LED	Solid green LED when the camera is on. Flashes green when commands are received from the remote control
4	Infrared Receiver	Receives the remote-control commands.
5	Tripod Screw	Used for securing to a tripod.
6	Hole	Used for positioning and securing to a tripod.
7	3G-SDI	BNC connector for 3G-SDI output signal
8	HDMI	HDMI output
9	USB	USB 3.0 Type-B output connector.
10	LINE IN	3.5mm stereo audio input
11	SYSTEM SELECT	Select the desired video format of the camera (see Rotary Dial section for the complete list of options).
12	RS232 IN	8-pin mini-DIN connection for controlling the PTZ camera using RS232 protocols
13	RS232 OUT	8-pin mini-DIN loop through RS232 connection to next camera
14	RS422/RS485	Phoenix connection for controlling the PTZ camera using RS422/RS485 protocols
15	LAN	RJ45 Ethernet port, PoE
16	DC12V	Power supply connection (when not using PoE)
17	Switch	Power on/off switch

## PRODUCT WIRING and CONNECTIONS DIAGRAM

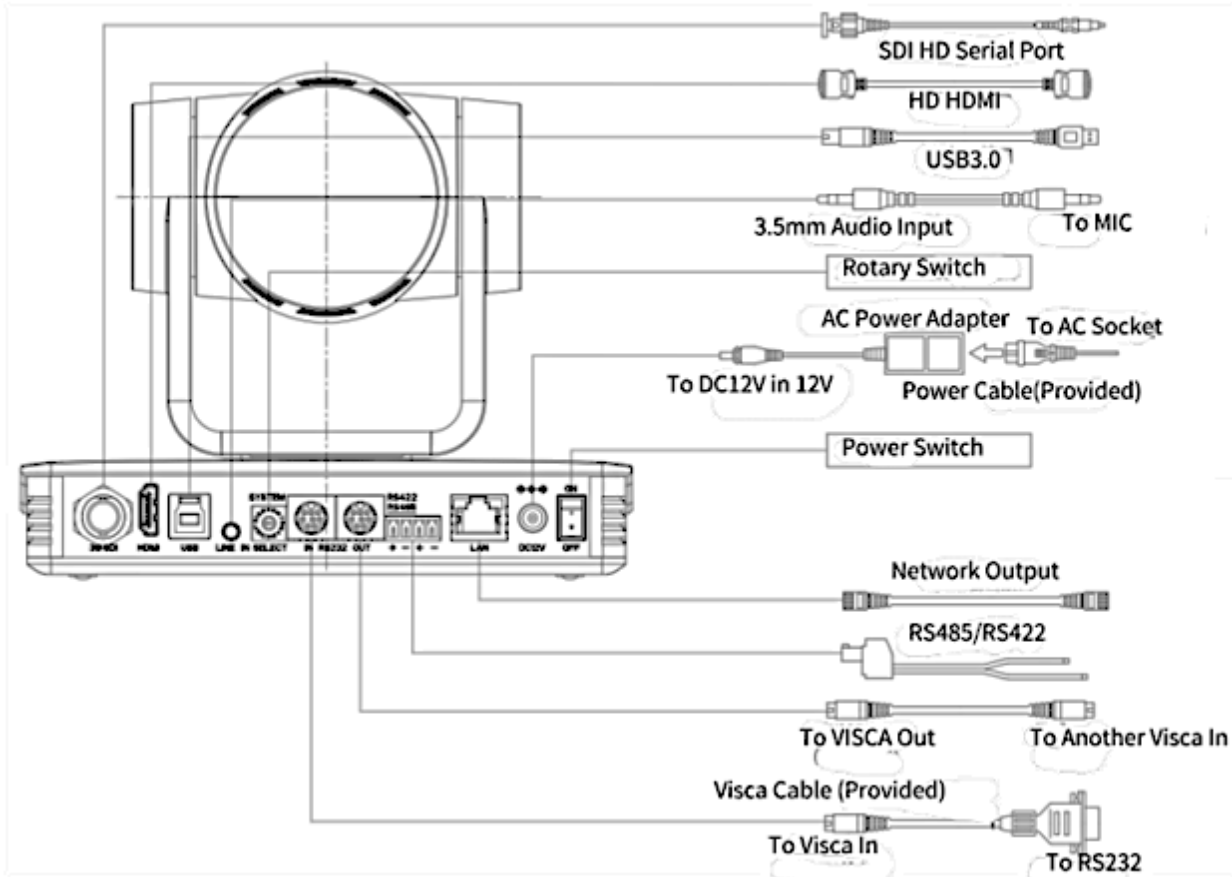

### RS-232 INTERFACE

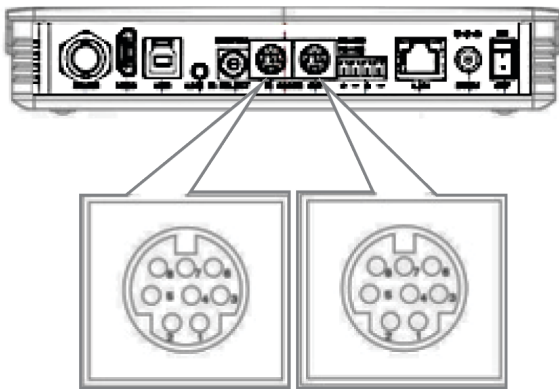

Connection to PC or Camera Controller

Camera MD8		Windows DB-9	
1	DTR	1	DCD
2	DSR	2	RXD
3	TXD	3	TXD
4	GND	4	DTR
5	RXD	5	GND
6	GND	6	DSR
7	IR OUT	7	RTS
8	NC	8	CTS
		9	RI

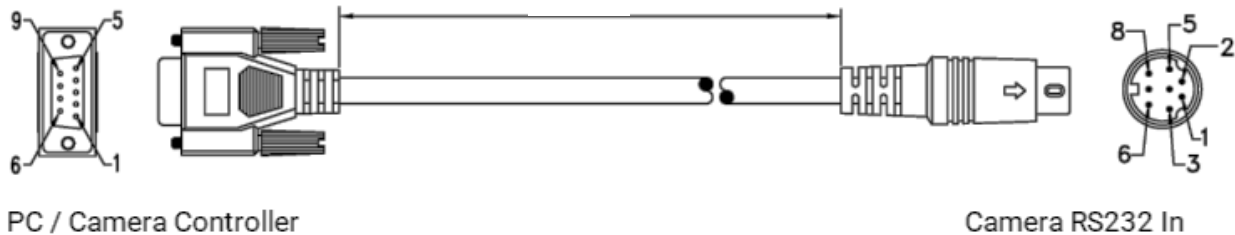



## RS-232 MINI-DIN 8-PIN

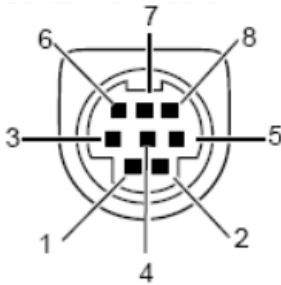

No.	Port	Definition
1	DTR	Data Terminal Ready
2	DSR	Data Set Ready
3	TXD	Transmit Data
4	GND	Signal Ground
5	TRXD	Receive Data
6	GND	Signal Ground
7	IR OUT	IR Commander Signal
8	NC	No Connection

## RS-232 (DB9)

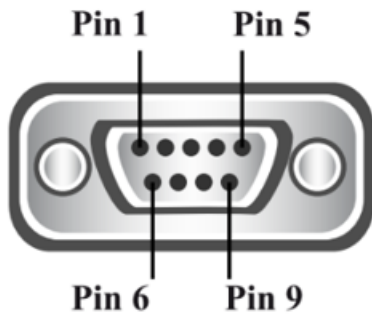

No.	Port	Definition
1	DCD	Data Carrier Detect
2	RXD	Receive Data
3	TXD	Transmit Data
4	DTR	Data Terminal Ready
5	GND	Signal Ground
6	DSR	Data Set Ready
7	RTS	Request to Send
8	CTS	Clear to Send
9	RI	Ring Indicator

## Rotary Dial

Rotate the dial to select the desired video format. A camera reboot is needed after changing the selection. By default, F is selected on the rotary dial, which allows for video format selection on the OSD menu (accessed with the remote control).

Video Format		
0	1080p60	6 1080p59.94
1	1080p50	7 1080p29.97
2	1080p30	8 720p59.94
3	1080p25	9 ----
4	720p60	A ----
5	720p50	B ----
		C ----
		D ----
		E ----
		F Select on OSD

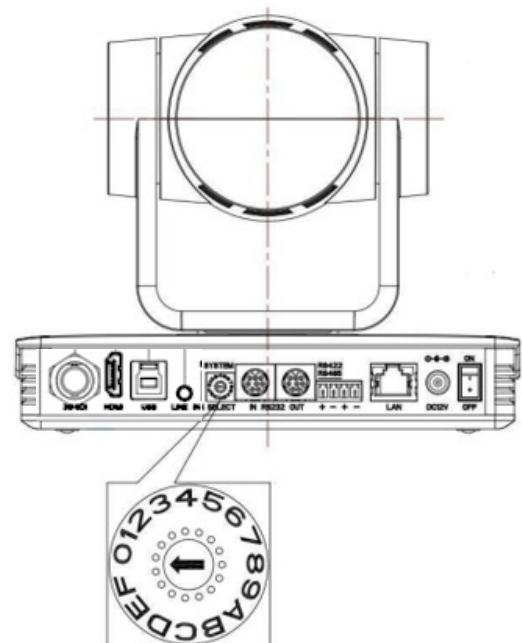

# Setup

---

## INSTALLATION

To install and connect the HT-CAM-4K-EPTZ camera, do the following:

### 1. Step One

Mark the mounting holes on the wall and drill the appropriate size hole to mount either the included M6 swelling bolts or drywall anchors (not included).

### 2. Step Two

Insert the limiting post onto the top of the wall mount.

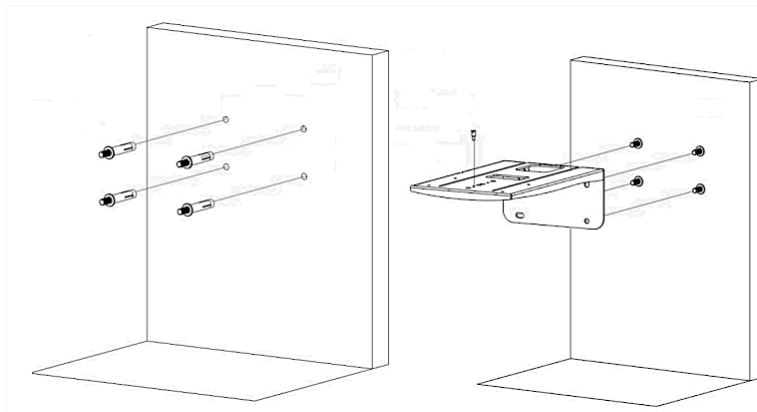

### 3. Step Three

Secure the wall mount to the wall using the included M6 nuts and washers, or, if using drywall anchors in step one, secure using the drywall anchor screws.

### 4. Step Four

Mount the camera to the top of the wall mount and secure with the included camera bolt.

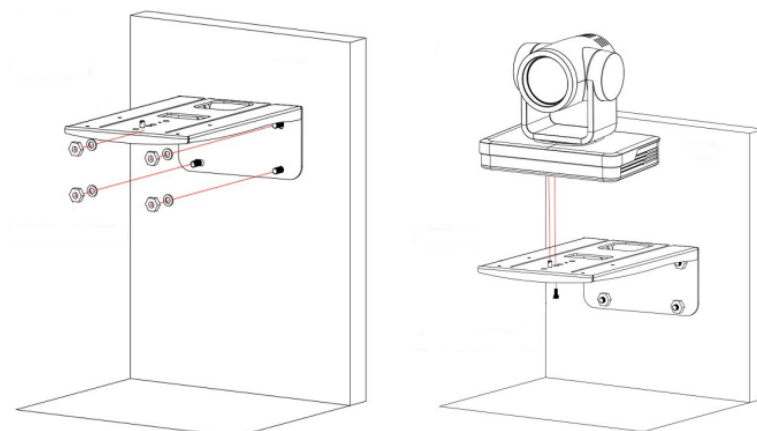

# Application Wiring

There are many applications for using the HT-CAM-1080PTZ camera depending on the needs of the user. The following are some examples, which can also be used simultaneously.

## USB-B OUTPUT

With the USB-B output the camera can be directly connected into any USB hub to be sent to the USB host for use with a laptop on a soft codec call. In this example, the laptop will be able to select the HT-CAM-1080PTZ camera as the USB camera to use for a Google Meet, Microsoft Teams, or Zoom call.

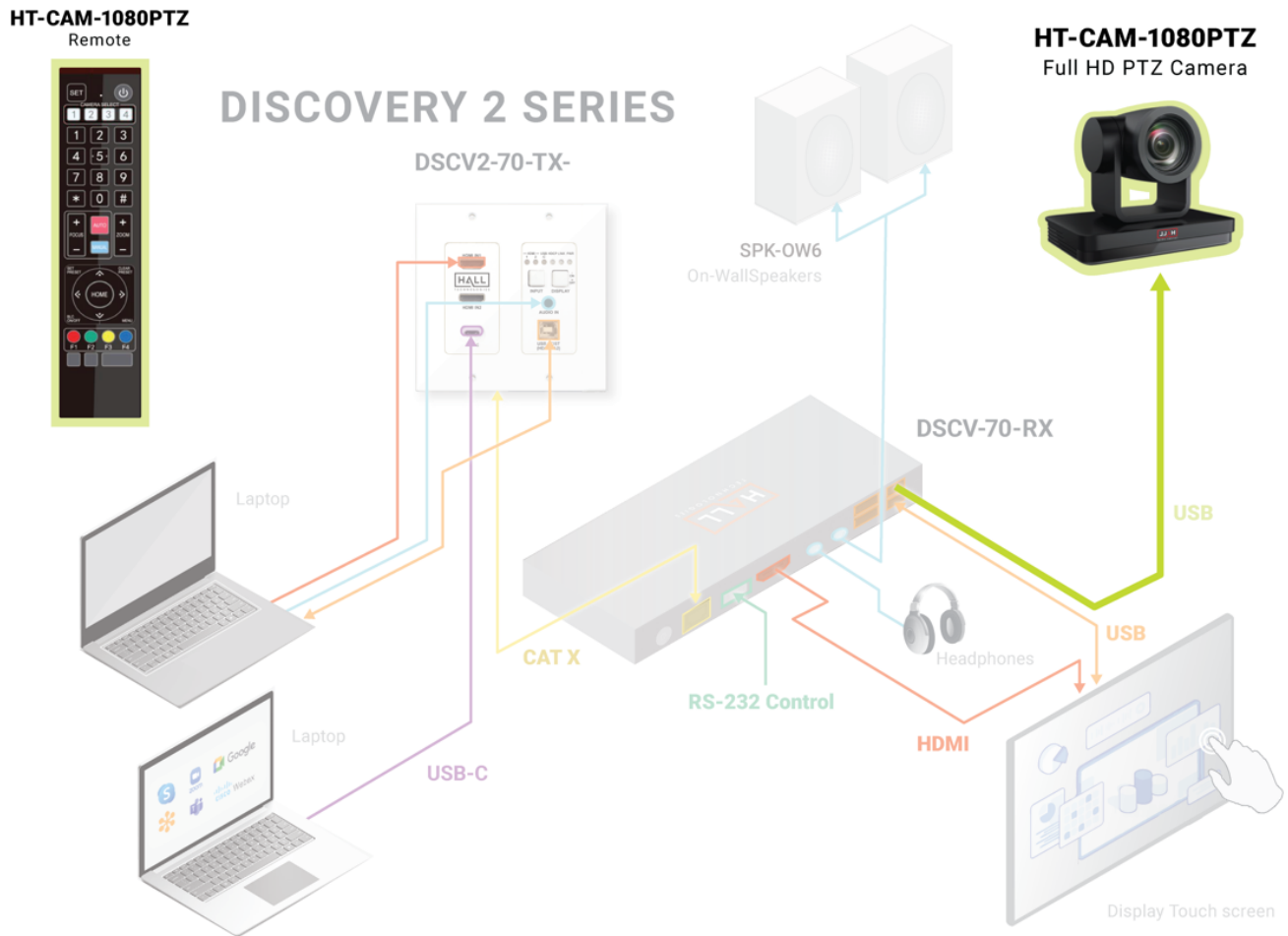

## HDMI & HD-SDI OUTPUTS

Using either the HDMI or HD-SDI video outputs, users can connect camera(s) to a larger video conference system. Pan, tilt, and zoom control can be accomplished over Ethernet or RS-232.





## STREAMING

Using the LAN port the HT-CAM-1080PTZ can stream directly to a server or provide an RTSP stream.

# Control – IR Remote Control

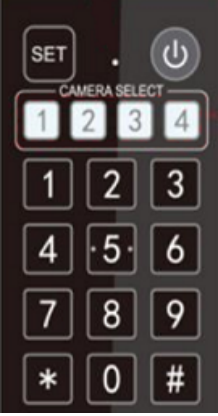
Many camera controls can be accessed using the included remote control.

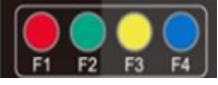
Remote Element	Description
	<p><b>Standby On:</b> To put the camera into standby mode, hold power button for 3 seconds. The camera's LED will flash green during the button press and then will turn red, and the camera will turn and face the back.</p> <p><b>Standby Off:</b> To exit out of standby mode, hold power button for 3 seconds. The camera will self-test and return to the home position.</p> <p><b>Set:</b> Set the remote to control different cameras.</p> <p><b>Camera Select:</b> Select the camera, 1~4, to control with the remote.</p> <p><b>Number Key:</b> Used to set or recall presets, 0 ~ 9.</p> <p><b>*, #:</b> Used for key combination use.</p> <p><b>Note:</b> See below for all possible key combinations.</p>
	<p><b>Auto:</b> Puts the camera's focus into auto mode.</p> <p><b>Manual:</b> Puts the camera's focus into manual mode</p> <p><b>Focus +/-:</b> Manually adjusts the camera's focus.</p> <p><b>Zoom +:</b> Increase the zoom on the camera.</p> <p><b>Zoom -:</b> Decrease the zoom on the camera.</p> <p><b>Note:</b> Holding the zoom +/- buttons will keep zooming in or out and stops as soon as the button is released.</p>
	<p><b>Set Preset:</b> To set a camera preset, press this button and then the desired 0~9 number.</p> <p><b>Clear Preset:</b> To clear a camera preset, press this button and then the desired 0~9 number.</p> <p><b>BLC ON/OFF:</b> This button turns on/off the back light feature.</p> <p><b>Menu:</b> Press this button to enter or exit the on-screen display (OSD) menu. (See next section to view the OSD settings.)</p> <p><b>Pan:</b> Press the arrow left/right buttons to pan the camera.</p> <p><b>Tilt:</b> Press the arrow up/down buttons to tilt the camera.</p> <p><b>Note:</b> Holding the buttons will continue to pan/tilt and stops as soon as the button is released.</p> <p><b>Home:</b> This button returns the camera to the middle position, or, acts as the enter button in the OSD menu.</p>
	<p><b>F1:</b> Turns off AI human detection.</p> <p><b>F2:</b> Turns on AI human detection.</p> <p><b>F3:</b> Toggles between Real-time Tracking mode and Region Tracking mode.</p> <p><b>F4:</b> Change tracking target on Real-time Tracking mode.</p>

## KEY COMBINATIONS

[ # ]	+	[ # ]	+	[ # ]	Clear all presets
[ * ]	+	[ # ]	+	[ 6 ]	Restore factory defaults
[ * ]	+	[ # ]	+	[ 9 ]	Flip switch
[ * ]	+	[ # ]	+	[ 3 ]	Menu language set to Chinese
[ * ]	+	[ # ]	+	[ 4 ]	Menu language set to English
[ * ]	+	[ # ]	+	[ Manual ]	Restore the default user name, password, and IP address
[ # ]	+	[ # ]	+	[ 0 ]	Switch video format to 1080p60
[ # ]	+	[ # ]	+	[ 1 ]	Switch video format to 1080p50
[ # ]	+	[ # ]	+	[ 2 ]	Switch video format to 1080i60
[ # ]	+	[ # ]	+	[ 3 ]	Switch video format to 1080i50
[ # ]	+	[ # ]	+	[ 4 ]	Switch video format to 720p60
[ # ]	+	[ # ]	+	[ 5 ]	Switch video format to 720p50
[ # ]	+	[ # ]	+	[ 6 ]	Switch video format to 1080p30
[ # ]	+	[ # ]	+	[ 7 ]	Switch video format to 1080p25
[ # ]	+	[ # ]	+	[ 8 ]	Switch video format to 720p30
[ # ]	+	[ # ]	+	[ 9 ]	Switch video format to 720p25



# OSD Menu

---

Pressing the menu key turns on the camera’s OSD menu for detailed setting changes.

## MAIN MENU

When accessing the menu and submenus, the up/down arrows on the remote move the cursor up/down to go to the desired setting/submenu, and the left/right arrows toggle between the options available for that setting. The [HOME] key is the enter button, and [MENU] returns to the previous menu or exits out of the OSD.

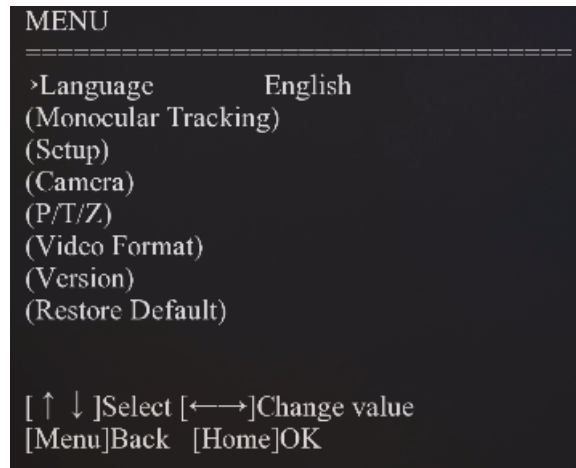

Menu Item	Description	Selection Options
Language	Change the language of the OSD menu.	<i>Simplified Chines   English</i>

## MONOCULAR TRACKING

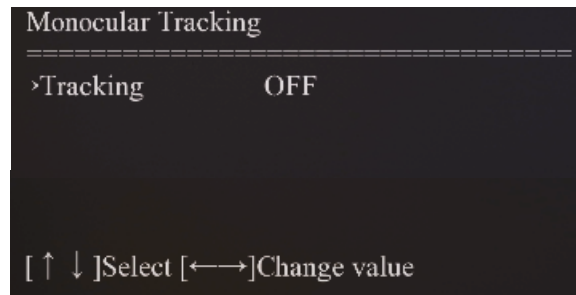

Menu Item	Description	Selection Options
Tracking	Turn on/off AI tracking and select between the two tracking modes.	<i>OFF   ON: Region Tracking   ON: Real-time Tracking</i>

## SETUP

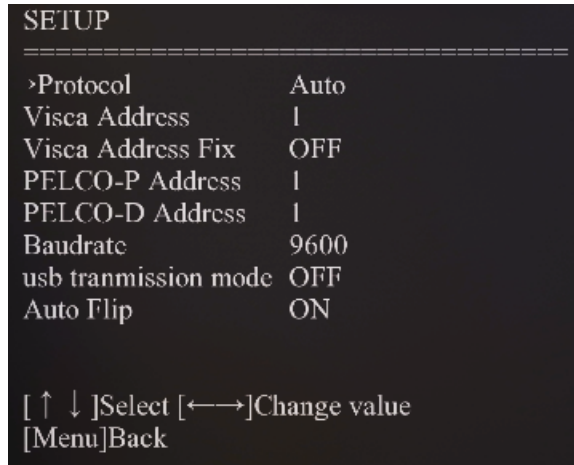

Menu Item	Description	Selection Options
<b>Protocol</b>	Select the control protocol	<i>Auto   VISCA   PELCO-D   PELCO-P</i>
<b>Visca Address</b>	Set the camera's Visca Address	<i>1 ~ 8</i>
<b>Visca Address Fix</b>	Fix the Visca address	<i>OFF   ON</i>
<b>Pelco-P Address</b>	Set the camera's Pelco-P address	<i>1 ~ 255</i>
<b>Pelco-D Address</b>	Set the camera's Pelco-D address	<i>1 ~ 255</i>
<b>Baud rate</b>	Set the camera's baud rate	<i>2400   4800   9600   38400   115200</i>
<b>USB Transmission</b>	Turns on/off USB video transmission	<i>OFF   ON</i>
<b>Auto Flip</b>	Automatically flips the picture if the camera is installed upside down.	<i>OFF   ON</i>

## CAMERA

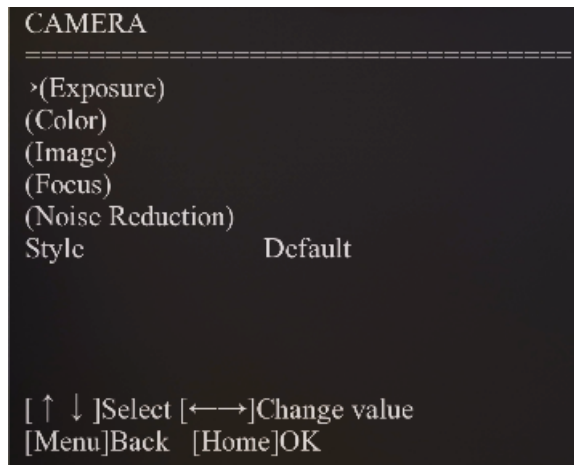

Menu Item	Description	Selection Options
<b>Style</b>	Change the image between various built-in presets.	<i>Default   Normal   Clarity   Bright   Soft</i>



## CAMERA - EXPOSURE

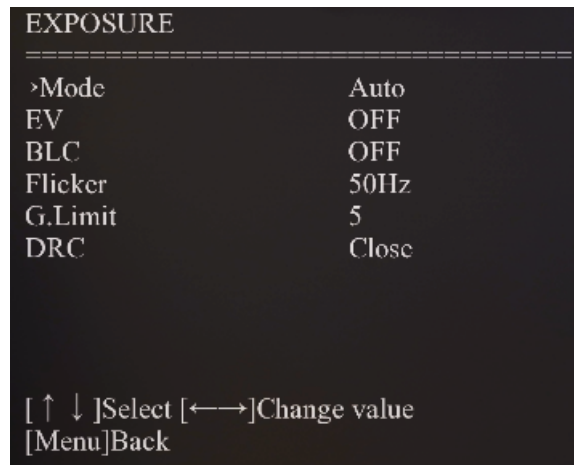

Menu Item	Description	Selection Options
<b>Mode</b>	Select the exposure settings. <ul style="list-style-type: none"> <li>SAE (Shutter Automatic Exposure) – sets the aperture based on desired shutter speed.</li> <li>AEAE (Aperture Automatic Exposure) – sets the shutter speed based on the desired iris opening.</li> </ul>	<i>Auto   Manual   SAE   AAE   Bright</i>
<b>EV</b>	Manually set the camera’s exposure value (only available in Auto mode).	<i>ON: -7 ~ 7   OFF</i>
<b>BLC</b>	Control the backlight compensation (only available in auto mode)	<i>ON   OFF</i>
<b>Flicker</b>	Prevent flicker on the video (only available in Auto, Shutter, and Brightness Priority modes)	<i>OFF   50Hz   60Hz</i>
<b>G. Limit</b>	Limit the camera’s gain (only available in Auto, Shutter, and Brightness Priority modes)	<i>0 ~ 15</i>
<b>DRC</b>	Modify the settings of the dynamic range compression	<i>Close   1 ~ 8</i>
<b>Shutter</b>	Select the priority setting of the shutter speed (only available in Manual and SAE modes)	<i>1/25   1/30   1/50   1/60   1/90   1/100   1/120   1/200   1/250   1/350   1/500   1/1000   1/2000   1/3000   1/4000   1/6000   1/10000</i>
<b>Iris</b>	Select the priority of the camera’s iris opening (only available in AAE mode)	<i>Close   F11   F9.6   F8.0   F6.8   F5.6   F4.8   F4.0   F3.4   F2.8   F2.4   F2.0   F1.8</i>

## CAMERA - COLOR

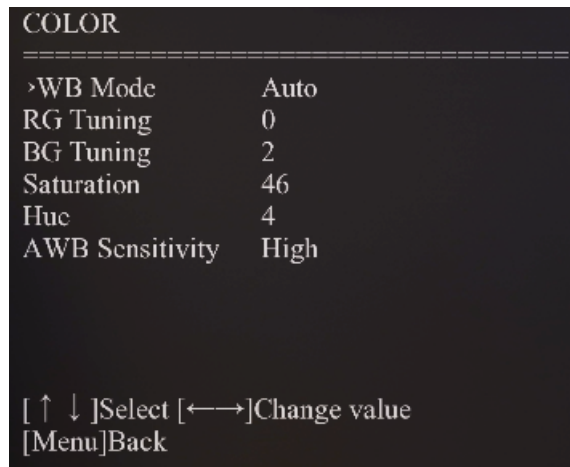

Menu Item	Description	Selection Options
<b>WB Mode</b>	Control the white balance	<i>Auto   Manual   One Push   VAR</i>
<b>RG Tuning</b>	Fine tune red gain (only available in Auto, One Push, and VAR modes)	<i>-10 ~ 10</i>
<b>BG Tuning</b>	Fine tune blue gain (only available in Auto, One Push, and VAR modes)	<i>-10 ~ 10</i>
<b>Saturation</b>	Set saturation levels	<i>0 ~ 100</i>
<b>Hue</b>	Control backlight compensation (only available in Auto mode)	<i>0 ~ 10</i>
<b>AWB Sensitivity</b>	Control the camera's auto white balance sensitivity (only available in Auto mode)	<i>HIGH   MIDDLE   LOW</i>

## CAMERA - IMAGE

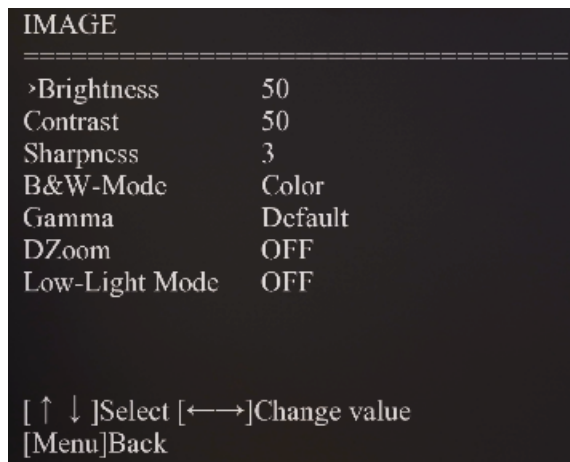

Menu Item	Description	Selection Options
<b>Brightness</b>	Modify the brightness levels	<i>0 ~ 100</i>
<b>Contrast</b>	Modify the contrast levels	<i>0 ~ 100</i>
<b>Sharpness</b>	Modify the sharpness levels	<i>0 ~ 15</i>
<b>B&amp;W Mode</b>	Change camera from color to black & white	<i>Color   Black/White</i>
<b>Gamma</b>	Modify the gamma settings	<i>Default   0.45   0.50   0.55   0.63</i>
<b>DZoom</b>	Turn on/off the digital zoom feature	<i>ON   OFF</i>
<b>Low-Light Mode</b>	Improve the image when the light is low	<i>ON   OFF</i>

## CAMERA - FOCUS

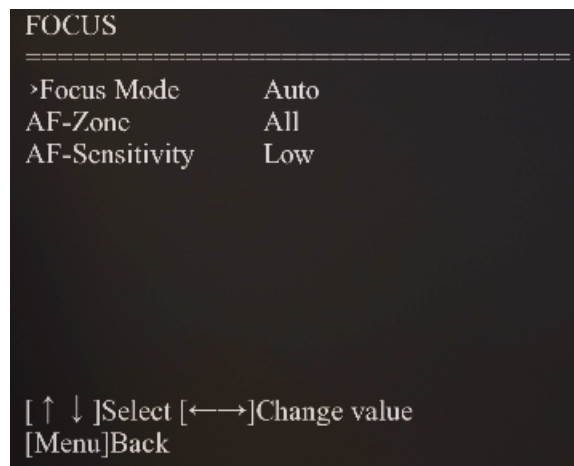

Menu Item	Description	Selection Options
<b>Focus Mode</b>	Toggle the focus mode	<i>Auto   Manual   One Push</i>
<b>AF Zone</b>	Set the camera's focus zone for the auto focus	<i>All   Top   Center   Bottom</i>
<b>AF Sensitivity</b>	Set the sensitivity of the auto focus mode	<i>Low   Middle   High</i>

## CAMERA – NOISE REDUCTION

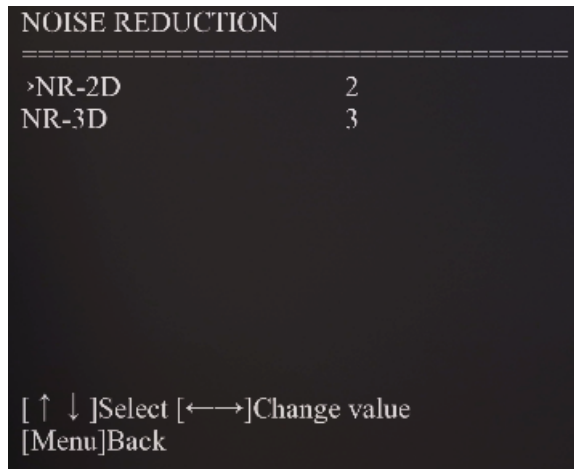

Menu Item	Description	Selection Options
NR-2D	Reduce noise from one frame to the next by removing any oddity that does not appear in each frame	OFF   0 ~ 7
NR-3D	Remove grainy fuzzy appearances of low light images	OFF   0 ~ 8

## PTZ

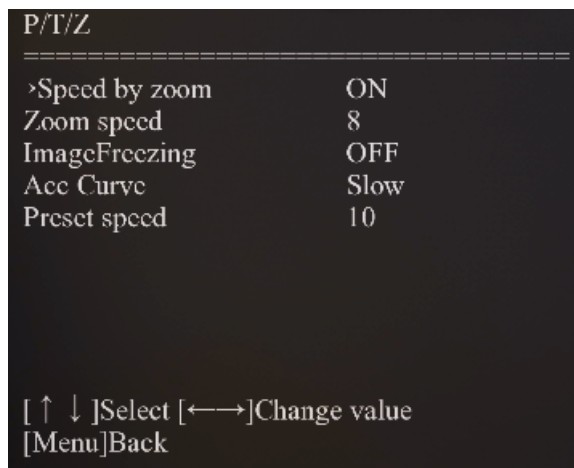

Menu Item	Description	Selection Options
Speed by zoom	Automatically slow down pan and tilt speeds when the camera is zoomed into objects that are far away	ON   OFF
Zoom Speed	Set the camera's zoom speed	1 ~ 8

Menu Item	Description	Selection Options
Image Freezing	Freeze the image while another image is recalled	<b>ON   OFF</b>
Acc Curve	Set the accelerating curve	<b>Slow   Fast</b>
Preset Speed	Set the speed of the camera when a preset is recalled	<b>1 ~ 10</b>

## VIDEO FORMAT

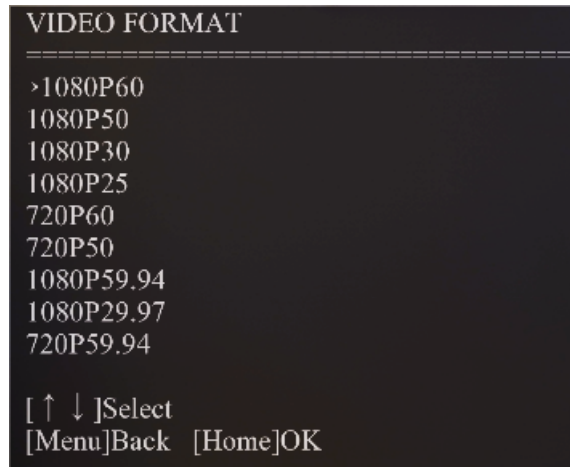

Menu Item	Description	Selection Options
Video Format	Select the desired resolution of the camera's video output	<b>(shown)</b>

## VERSION

Displays the camera version.

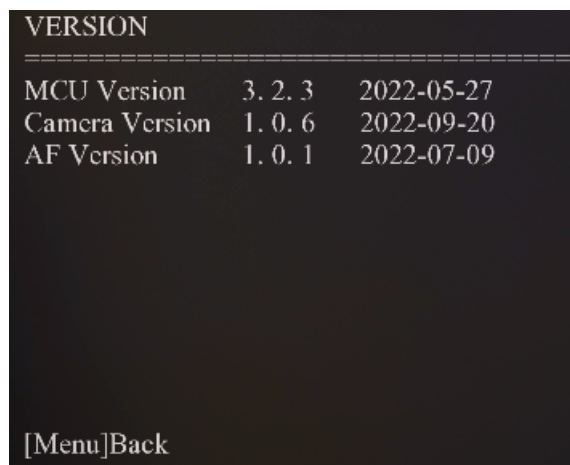

## RESTORE DEFAULT

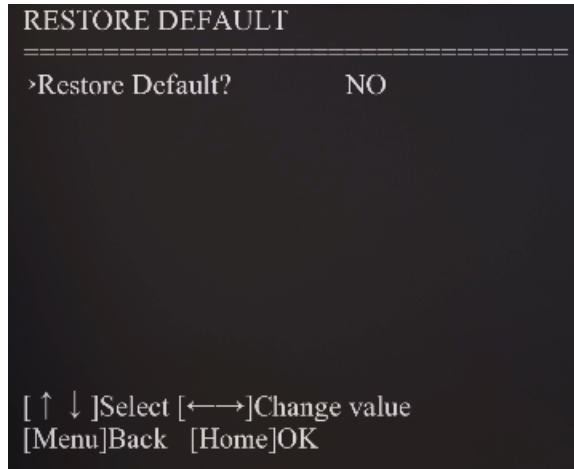

Menu Item	Description	Selection Options
Restore Default?	Restore factory defaults (color style and video format are not restored to factory defaults)	YES / NO

# Web UI

---

The Web UI for this device allows for more advanced controls and device settings. This Web UI can be accessed through a modern browser, e.g. Chrome, Safari, Firefox, IE10+, etc.

To get access to the Web UI:

1. Connect the LAN port of the device to a local area network. The default IP address of the camera is 192.168.5.163.
2. Connect the PC to the same network as the device.
3. Input the device's IP address in the browser and press Enter, the following window pops up.



4. Input Username and Password (default: admin / admin) and click Login to enter the main page of Web UI.

The Web UI main page consists of three tabs along the top right: Preview, Monocular Tracking, and Configuration. The last button on the right is Logout.

PREVIEW

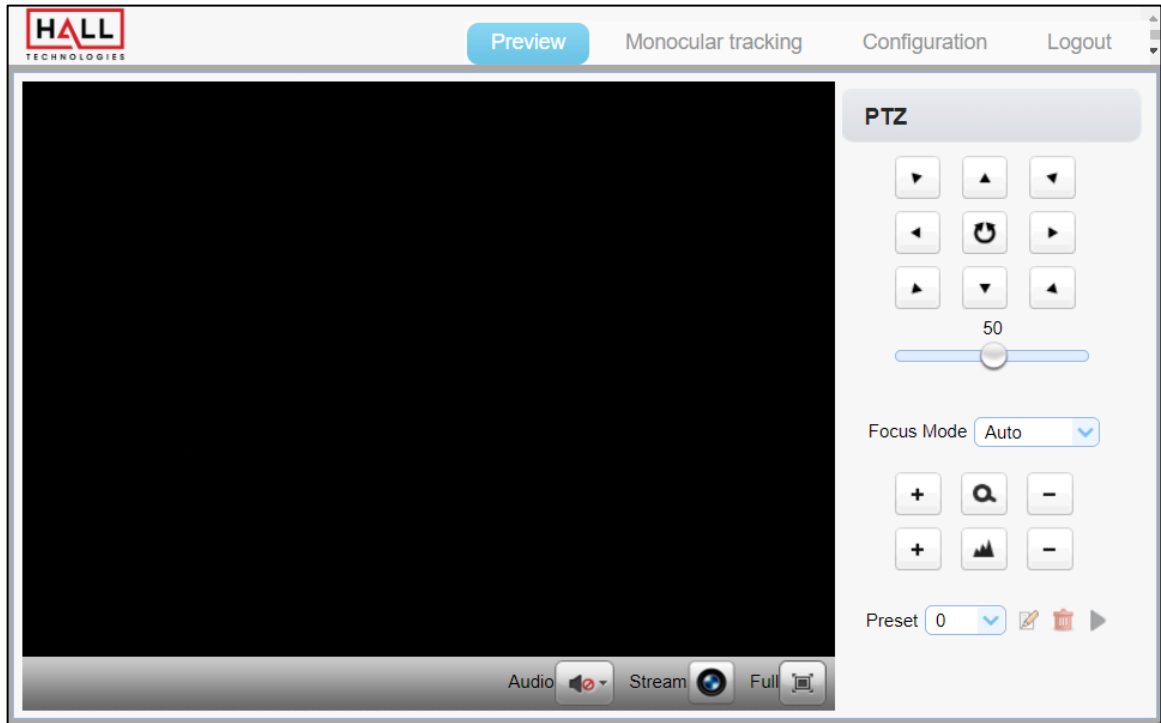

UI Element	Description
	<p><b>Pan:</b> Press the arrow left/right buttons to pan the camera.</p> <p><b>Tilt:</b> Press the arrow up/down buttons to tilt the camera.</p> <p><b>Both:</b> Press the diagonal arrows to pan and tilt at the same time.</p> <p><b>Home:</b> Press the center button to return the camera to the home position.</p> <p><b>Note:</b> Holding the buttons will continue to pan/tilt and stops as soon as the button is released.</p>
	<p>Increase or decrease camera pan/tilt speed.</p>
<p><b>Focus Mode</b></p>	<p>Toggle the focus mode: <b>Auto   Manual   One Push</b></p> <p><b>One Push:</b> the one push auto focus is a function to automatically adjust the focus. The focus area is 1/3 of the screen height and 1/4 of the width.</p>
	<p>Zoom: Press [+] to zoom in and [-] to zoom out.</p>
	<p>Focus: Press [+] or [-] to adjust focus (only available in Manual mode).</p>
	<p>Store, delete, and recall camera presets.</p> <p><b>Set Preset:</b> select the # to store and press the save button.</p> <p><b>Delete Preset:</b> select the # to delete and then press the delete button.</p> <p><b>Recall Preset:</b> select the # to recall and then press the play button.</p>
	<p><b>Audio Mute:</b> Click the button to mute audio.</p> <p><b>Stream Mode:</b> Toggle the preview between Main Stream and Sub Stream.</p> <p><b>Full Mode:</b> Click to enter full screen preview mode. Click “ESC” to escape.</p>



# MONOCULAR TRACKING



UI Element	Description
<b>Tracking</b>	Click "On" to enable camera tracking or "Off" to disable it.
<b>Mode</b>	<p>Presenter (aka. Real-time Tracking): the camera will start tracking when a human enters the camera's view and will stop tracking and return to home when the human exits the camera's view.</p> <p>Zone (aka. Regional Tracking): the camera will start tracking when an object is moving within the tracked region.</p>
<b>Click Track</b>	Enable or disable the click track function. When more than one human is in the camera's view, the camera will track the first human with a red frame and the other human will have a blue frame. To change the tracking to the other human, click on the blue frame and the camera will begin to track that human.
<b>Regional Settings</b>	<p>To set the regions to be tracked, move the camera's view to the desired region and click "Set". Click on the box to enable the tracked region.</p> <p>Note: A minimum of 2 regions needs to be set, and each preset preview image must be continuous from left to right with overlap.</p>

## CONFIGURATION: AUDIO

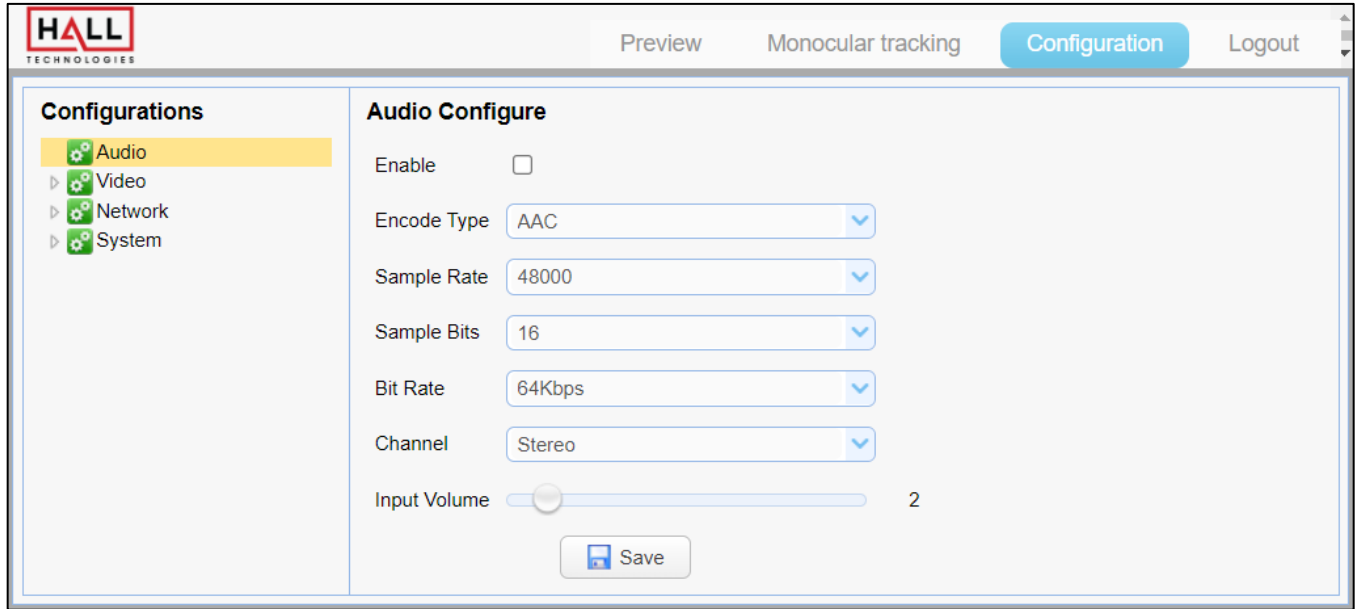

UI Element	Description
<b>Enable</b>	Click to enable changes to the audio settings. (Unchecked grays out settings.)
<b>Encode Type</b>	Set the desired audio encoding standard: MP3   AAC   G711A
<b>Sample Rate</b>	Select the desired audio sample rate: 16,000   32,000   44,100   48,000
<b>Sample Bits</b>	16 bits is the only option currently.
<b>Bit Rate</b>	Set the desired bit rate: 64Kbps   48Kbps   64Kbps   96Kbps   128Kbps
<b>Channel</b>	Set the desired channel output: stereo   mono
<b>Input Volume</b>	Used to set the gain of the input audio.
<b>Save</b>	Press to save changes. Once saved, a small pop-up window will appear in the bottom right of the screen saying the changes made have been saved. <b>Note:</b> Some changes require the camera to be rebooted.

## CONFIGURATION: VIDEO CONFIGURE / VIDEO ENCODE

The camera has the ability to have two streams: Main Stream and Sub Stream. The settings for those streams are found on this page.

The screenshot shows the 'Configuration' page for 'Video Encode'. The sidebar on the left lists various configuration categories: Audio, Video (expanded), Video Encode (selected), Stream Publish, RTP Multicast, Video Parameters, Video OSD, OSD Font Size, Video Out, Network, and System. The main content area is titled 'Video Encode' and is split into two columns: 'Main Stream' and 'Sub Stream'. The settings for each stream are as follows:

Stream	Main Stream	Sub Stream
Compressed Format	H.264	H.264
Profile	HP	HP
Image Size	1920*1080	320*180
Rate Control	CBR	CBR
Image Quality	Best	Better
Bit Rate(Kb/s)	4096	512
Frame Rate(F/S)	25	25
I-Frame Interval	75	75
I-Frame Min QP	20	20
Stream Name	live/av0	live/av1

A 'Save' button is located at the bottom center of the configuration area.

UI Element	Description
<b>Compressed Format</b>	Set the compressed format; H.264 or H.265.
<b>Profile</b>	<ul style="list-style-type: none"> <li>• <b>BP (Base Profile):</b> Primarily for low-cost applications, used in some videoconferencing and mobile applications.</li> <li>• <b>MP (Main Profile):</b> Used for standard-definition digital TV broadcasts.</li> <li>• <b>HP (High Profile):</b> Primary profile for broadcast and storage applications, particularly for high-definition applications.</li> </ul>
<b>Image Size</b>	Set the image size of the stream. <ul style="list-style-type: none"> <li>• <b>Main Stream:</b> 640x480   1280x720   1920x1080</li> <li>• <b>Sub Stream:</b> 320x180   320x240   640x360   640x480   1280x720   1920x1080</li> </ul>
<b>Rate Control</b>	<ul style="list-style-type: none"> <li>• <b>CBR (Constant Bitrate):</b> keeps the bitrate constant but allows video quality to vary.</li> <li>• <b>VBR (Variable Bitrate):</b> allows the bitrate to vary but maintains the quality.</li> </ul>
<b>Image Quality</b>	These are set at the factory and cannot be changed.
<b>Bit Rate (Kb/S)</b>	Used to set the video bitrate. The higher the bitrate the better the quality but also the higher the bandwidth. It is recommended to use no more than 50% of your available upload bandwidth capacity on a dedicated line. <ul style="list-style-type: none"> <li>• <b>Main Stream:</b> 64 ~ 102,400 Kbps</li> <li>• <b>Sub Stream:</b> 64 ~ 40,960 Kbps</li> </ul>

UI Element	Description
Frame Rate (F/S)	Used to set the video frame rate. For live streaming the frame rate should be set to at least 30fps. <ul style="list-style-type: none"> <li>• <b>Main Stream:</b> 5 ~ 60fps</li> <li>• <b>Sub Stream:</b> 5 ~ 30fps</li> </ul>
I Frame Interval	Used to set the number of interval frames between two I-frames (key frames). The larger the value, the smaller the storage space occupied by the compressed video. <ul style="list-style-type: none"> <li>• <b>Main Stream:</b> 1 ~ 300</li> <li>• <b>Sub Stream:</b> 1 ~ 150</li> </ul>
I Frame Min QP	Used to set the quality of the frames and is typically used for more advanced streaming. <ul style="list-style-type: none"> <li>• <b>Main Stream:</b> 10 ~ 51</li> <li>• <b>Sub Stream:</b> 10 ~ 51</li> </ul>
Stream Name	Configure the desired stream name. The name set here will be appended to the camera's IP address. The camera supports two streams: RTSP and RTMP <ul style="list-style-type: none"> <li>• <b>RTSP Streams</b> (mostly used for localized video from IP cameras): <ul style="list-style-type: none"> <li>○ Main stream: rtsp://192.168.5.163:554/live/av0</li> <li>○ Sub stream: rtsp://192.168.5.163:554/live/av1</li> </ul> </li> <li>• <b>RTMP Streams</b> (mostly used by broadcasters): <ul style="list-style-type: none"> <li>○ Main stream: rtmp://192.168.5.163:1935/live/av0</li> <li>○ Sub stream: rtmp://192.168.5.163:1935/live/av1</li> </ul> </li> </ul>
Save	Press to save changes. Once saved, a small pop-up window will appear in the bottom right of the screen saying the changes made have been saved. <b>Note:</b> Some changes require the camera to be rebooted.

## CONFIGURATION: VIDEO CONFIGURE / STREAM PUBLISH

This page is used to push streams to a network server. The camera needs to be on the same network as the server.

The screenshot shows the 'Stream Publish' configuration page in the HALL TECHNOLOGIES interface. The page is split into two columns: 'Main Stream' and 'Sub Stream'. The 'Main Stream' column has the following settings: 'Enable' is unchecked, 'Protocol Type' is set to 'RTMP', 'Host Address' is '192.168.5.11', 'Host Port' is '1935', and 'Stream Name' is 'live/av0'. The 'Sub Stream' column has: 'Enable' is unchecked, 'Protocol Type' is 'RTMP', 'Host Address' is '192.168.5.11', 'Host Port' is '1935', and 'Stream Name' is 'live/av1'. Below these are input fields for 'Username', 'Password', 'Password for stream encryption', and 'Crypto key length in bytes' (set to 0). A 'Save' button is located at the bottom center.

UI Element	Description
Enable	Click on the check box to enable/disable the streams.
Protocol Type	Select the desired streaming protocol type: RTSP   RTMP   SRT
Host Address	Enter the host address the stream is to be pushed to. This can be either a domain name or an IP address
Host Port	Enter the host port of the server receiving the stream
Stream Name	Enter the name of the stream name. <ul style="list-style-type: none"> <li>Example: <ul style="list-style-type: none"> <li>rtmp://host domain name: host port/live/xxx</li> <li>rtmp://host IP address: host port/live/xxx</li> </ul> </li> </ul>
Username	Enter the username of the server. (Leave empty if no username on server.)
Password	Enter the password of the server. (Leave empty if no password on server.)
Password for stream encryption	Currently stream encryption is not enabled.
Crypto key length in bytes	Currently crypto key length is not enabled.
Save	Press to save changes. Once saved, a small pop-up window will appear in the bottom right of the screen saying the changes made have been saved. Note: <b>Some changes require the camera to be rebooted.</b>

## CONFIGURATION: VIDEO CONFIGURE / RTP MULTICAST

The screenshot shows the HALL TECHNOLOGIES configuration interface. The top navigation bar includes 'Preview', 'Monocular tracking', 'Configuration' (highlighted), and 'Logout'. The left sidebar lists various configuration categories: Audio, Video (expanded), RTP Multicast (highlighted), Video Parameters, Video OSD, OSD Font Size, Video Out, Network, and System. The main configuration area is titled 'Multicast/Uncast' and is divided into 'Main Stream' and 'Sub Stream' columns. The 'Main Stream' column has an 'Enable' checkbox (unchecked), a 'Protocol Type' dropdown set to 'RTP', an 'Address' field with '224.1.2.3', a 'Port' field with '4000', and an 'Access Method' field with 'rtmp://224.1.2.3:4000'. The 'Sub Stream' column has an 'Enable' checkbox (unchecked), a 'Protocol Type' dropdown set to 'RTP', an 'Address' field with '224.1.2.3', a 'Port' field with '4002', and an 'Access Method' field with 'rtmp://224.1.2.3:4002'. A 'Save' button is located at the bottom center of the configuration area.

UI Element	Description
Enable	Click to enable multicast/unicast streams.

UI Element	Description
Protocol Type	Select the desired multicast/unicast stream. <ul style="list-style-type: none"> <li><b>RTP:</b> transport protocol for real-time data, providing timestamp, sequence number, and other means to handle potential timing issues.</li> <li><b>TS:</b> transport stream for transmission of audio, video, and PSIP data.</li> </ul>
Address	Enter the desired multicast stream address.
Port	Enter the desired port.
Save	Press to save changes. Once saved, a small pop-up window will appear in the bottom right of the screen saying the changes made have been saved. Note: <b>Some changes require the camera to be rebooted.</b>

## CONFIGURATION: VIDEO CONFIGURE / VIDEO PARAMETERS / FOCUS

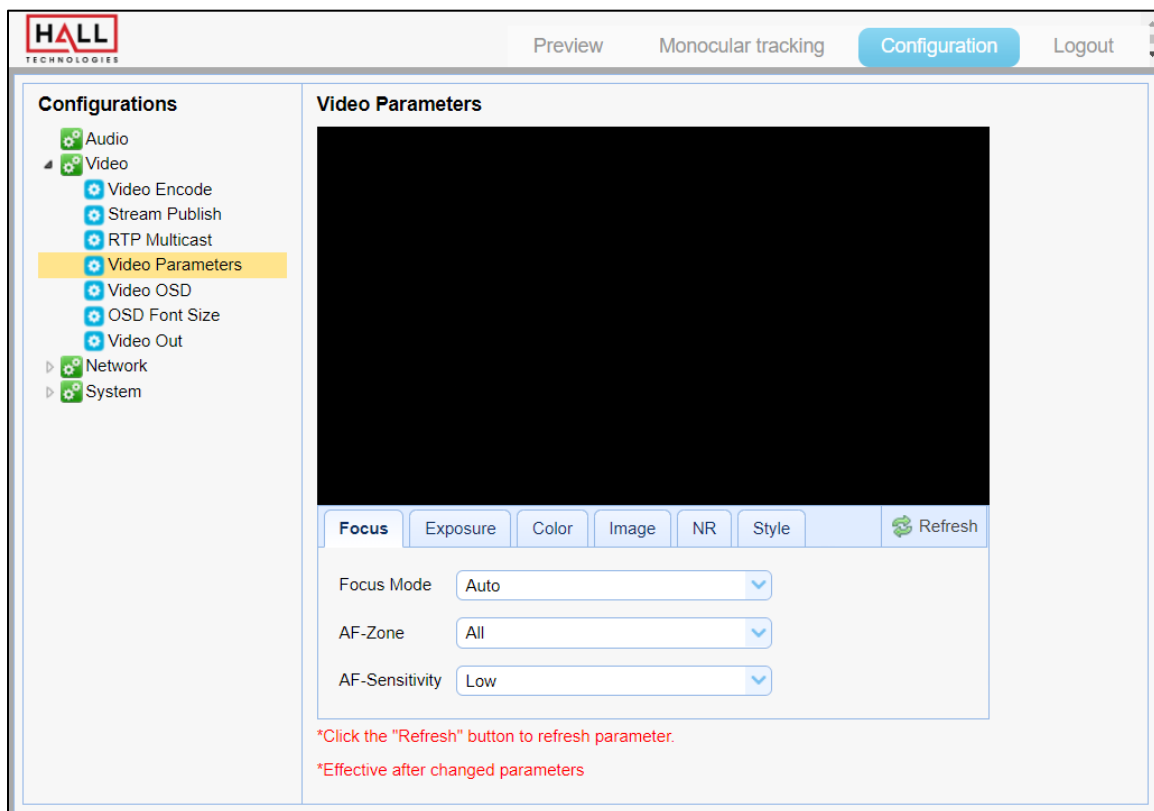

UI Element	Description
Focus Mode	Toggle the focus mode: <b>Auto   Manual   One Push</b>
AF-Zone	Set the camera's focus zone for the auto focus: <b>All   Top   Center   Bottom</b>
AF-Sensitivity	Set the sensitivity of the auto focus mode: <b>High   Middle   Low</b>

## CONFIGURATION: VIDEO CONFIGURE / VIDEO PARAMETERS / EXPOSURE

The screenshot shows the 'Configuration' page for 'Video Parameters' under the 'Exposure' tab. The left sidebar lists various configuration categories: Audio, Video (expanded), Video Encode, Stream Publish, RTP Multicast, Video Parameters (highlighted), Video OSD, OSD Font Size, Video Out, Network, and System. The main area features a video preview window (currently black) and a settings panel with the following controls:

- Mode:** A dropdown menu set to 'Auto'.
- EV:** A toggle switch set to 'OFF'.
- BLC:** A toggle switch set to 'OFF'.
- Flicker:** A dropdown menu set to '50Hz'.
- G.Limit:** A horizontal slider set to 5.
- DRC:** A dropdown menu set to 'OFF'.

Below the settings panel, there are two red text annotations:

- \*Click the "Refresh" button to refresh parameter.
- \*Effective after changed parameters

UI Element	Description
<b>Mode</b>	Set the exposure settings: <b>Auto   Manual   SAE   AAE   Bright</b> <ul style="list-style-type: none"> <li>• <b>SAE (Shutter Automatic Exposure):</b> camera measures light and automatically sets the aperture based on the desired shutter speed.</li> <li>• <b>AAE (Aperture Automatic Exposure):</b> camera measures light and automatically sets the shutter speed based on the desired iris opening (aperture).</li> </ul>
<b>Flicker</b>	Prevent flicker on the video: <b>OFF   50Hz   60Hz</b>
<b>G. Limit</b>	Limit the camera's gain: <b>0 to 15</b>
<b>Iris</b>	Select the priority setting of the camera's iris opening: <b>Close   F11   F9.6   F8.0   F6.8   F5.6   F4.8   F4.0   F3.4   F2.8   F2.4   F2.0   F1.8</b>
<b>DRC</b>	Modify the settings of the dynamic range compression: <b>Close   1 to 8</b>

UI Element	Description
<b>EV</b>	Manually set the camera's exposure value (only available in Auto mode): <b>ON   OFF</b>
<b>BLC</b>	Control backlight compensation (only available in Auto mode): <b>ON   OFF</b>
<b>Shutter</b>	Select the priority setting of the camera's shutter speed (only available in Manual and SAE mode): <b>1/25   1/30   1/50   1/60   1/90   1/100   1/120   1/200   1/250   1/350   1/500   1/1000   1/2000   1/3000   1/4000   1/6000   1/10000</b>

## CONFIGURATION: VIDEO CONFIGURE / VIDEO PARAMETERS / COLOR

The screenshot shows the 'Configuration' page for 'Video Parameters / COLOR'. The left sidebar lists various configuration categories: Audio, Video (expanded), Video Encode, Stream Publish, RTP Multicast, Video Parameters (highlighted), Video OSD, OSD Font Size, Video Out, Network, and System. The main content area is titled 'Video Parameters' and features a large black video preview window. Below the preview are tabs for 'Focus', 'Exposure', 'Color' (selected), 'Image', 'NR', and 'Style', along with a 'Refresh' button. Under the 'Color' tab, the following settings are visible:

- WB Mode: Auto (dropdown menu)
- RG Tuning: 0 (slider)
- BG Tuning: 2 (slider)
- Saturation: 46 (slider)
- Hue: 4 (slider)
- AWB Sensitivity: Low (dropdown menu)

At the bottom of the configuration area, there are two red text annotations: '\*Click the "Refresh" button to refresh parameter.' and '\*Effective after changed parameters'.

UI Element	Description
<b>WB Mode</b>	Control the white balance: <b>Auto   Manual   One Push   VAR</b>
<b>RG Tuning</b>	Fine tune red gain: <b>-10 to 10</b>
<b>BG Tuning</b>	Fine tune blue gain: <b>-10 to 10</b>



UI Element	Description
Saturation	Set saturation levels: <b>0 to 100</b>
Hue	Control backlight compensation: <b>0 to 100</b>
AWB Sensitivity	Control the camera's auto white balance sensitivity: <b>HIGH   MIDDLE   LOW</b>

## CONFIGURATION: VIDEO CONFIGURE / VIDEO PARAMETERS / IMAGE

The screenshot shows the HALL Technologies Configuration interface. The top navigation bar includes 'Preview', 'Monocular tracking', 'Configuration' (selected), and 'Logout'. The left sidebar lists configuration categories: Audio, Video (expanded), Network, and System. Under Video, 'Video Parameters' is selected. The main area displays 'Video Parameters' with a video preview window (currently black). Below the preview are tabs for 'Focus', 'Exposure', 'Color', 'Image' (selected), 'NR', and 'Style', along with a 'Refresh' button. The 'Image' tab contains the following settings:

- Brightness: Slider set to 50
- Contrast: Slider set to 50
- Sharpness: Slider set to 3
- Gamma: Dropdown menu set to 'Default'
- B&W Mode: 'Color' button
- Auto Flip: 'ON' button
- DZoom: 'OFF' button
- Low-Light Mode: 'OFF' button

Below the settings, there are two red notes:

- \*Click the "Refresh" button to refresh parameter.
- \*Effective after changed parameters

UI Element	Description
Brightness	Modify the brightness levels (how dark or light the image is): <b>0 to 100</b>
Contrast	Modify the contrast levels. Higher contrast helps the image look lively; lower contrast makes the image look flat and monotonous: <b>0 to 100</b>

UI Element	Description
Sharpness	Modify the sharpness settings, which describes clarity of detail: <b>0 to 15</b>
Gamma	Modify the gamma settings: <b>Default   0.45   0.50   0.55   0.63</b>
B&W Mode	Change the camera from color to black & white: <b>Color   Black/White</b>
Auto Flip	Automatically flip the picture when the camera is installed upside down: <b>ON   OFF</b>
DZoom	Turn on or off the digital zoom feature: <b>ON   OFF</b>
Low-Light Mode	Improve the image when the light is low: <b>ON   OFF</b>

## CONFIGURATION: VIDEO CONFIGURE / VIDEO PARAMETERS / NR

UI Element	Description
NR-2D	Reduce noise from one frame to the next by removing any oddity that does not appear in each frame: <b>OFF   1 to 8</b>
NR-3D	Remove grainy fuzzy appearances of low light images: <b>OFF   1 to 8</b>

## CONFIGURATION: VIDEO CONFIGURE / VIDEO PARAMETERS / STYLE

The screenshot shows the HALL TECHNOLOGIES configuration interface. At the top, there are navigation tabs: "Preview", "Monocular tracking", "Configuration" (selected), and "Logout". On the left, a "Configurations" sidebar lists categories: Audio, Video (expanded), Video Encode, Stream Publish, RTP Multicast, Video Parameters (highlighted), Video OSD, OSD Font Size, Video Out, Network, and System. The main area is titled "Video Parameters" and contains a large black video preview window. Below the preview are tabs for "Focus", "Exposure", "Color", "Image", "NR", "Style" (selected), and a "Refresh" button. Under the "Style" tab, there is a dropdown menu currently set to "Default". Below the interface, two red text annotations are present: "\*Click the 'Refresh' button to refresh parameter." and "\*Effective after changed parameters".

UI Element	Description
Style	Change the image between the various built-in presets: Default   Normal   Clarity   Bright   Soft

## CONFIGURATION: VIDEO CONFIGURE / VIDEO OSD

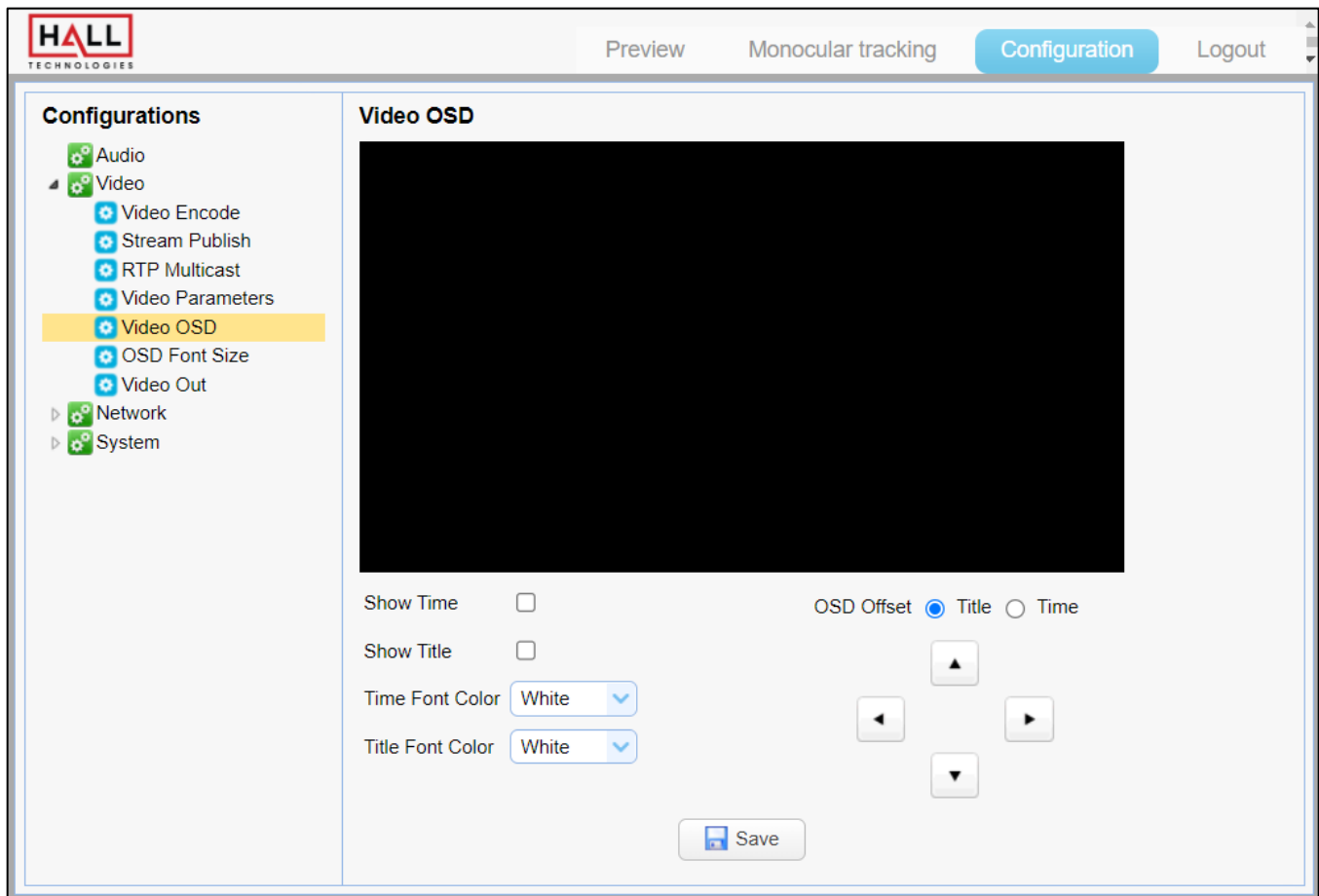

UI Element	Description
<b>Show Time</b>	Click to show a time overlay on the stream.
<b>Show Title</b>	Click to show a title (camera name) overlay on the stream.
<b>Time Font Color</b>	Select the desired time font color: <b>White   Black   Yellow   Red   Blue</b>
<b>Title Font Color</b>	Select the desired title font color: <b>White   Black   Yellow   Red   Blue</b>
<b>OSD Offset</b>	Click Title or Time and then adjust with the arrows to move the title or time overlays on the stream.
<b>Save</b>	Press to save changes. Once saved, a small pop-up window will appear in the bottom right of the screen saying the changes made have been saved. Note: <b>Some changes require the camera to be rebooted.</b>

## CONFIGURATION: VIDEO CONFIGURE / OSD FONT SIZE

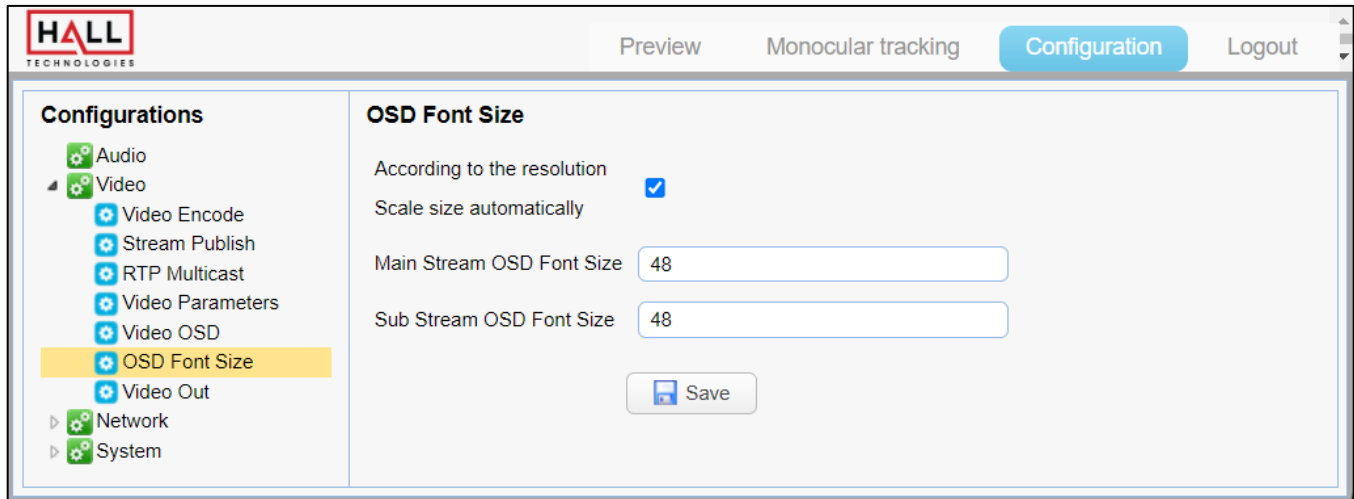

UI Element	Description
Scale size automatically	Click to have the size of the overlay text adjust according to the resolution.
Main Stream OSD Font Size	Manually set the size of the overlay text on the Master Stream.
Sub Stream OSD Font Size	Manually set the size of the overlay text on the Sub Stream.
Save	Press to save changes. Once saved, a small pop-up window will appear in the bottom right of the screen saying the changes made have been saved. Note: <b>Some changes require the camera to be rebooted.</b>

## CONFIGURATION: VIDEO CONFIGURE / VIDEO OUT

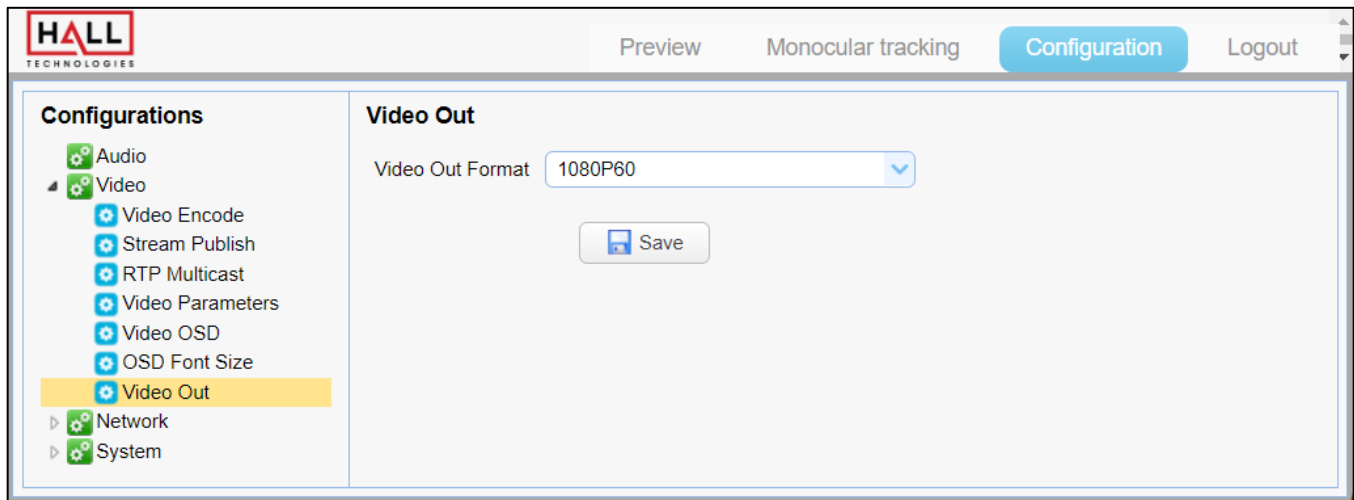

UI Element	Description
Video Out Format	Select the desired video output on the camera: <b>1080p60   1080p50   1080p30   1080p25   720p60   720p50   1080p59.94   1080p29.97   720p59.94</b>
Save	Press to save changes. Once saved, a small pop-up window will appear in the bottom right of the screen saying the changes made have been saved. Note: <b>Some changes require the camera to be rebooted.</b>

## CONFIGURATION: NETWORK CONFIGURE / NETWORK PORT

The screenshot shows the 'Network Ports' configuration page. On the left, a sidebar lists configuration categories: Audio, Video, Network (expanded), and System. Under 'Network', 'Network Ports' is selected. The main content area displays the following settings:

- Data Port: 3000
- Web Port: 80
- ONVIF Port: 2000
- SOAP Port: 1936
- RTMP Port: 1935
- RTSP Port: 554
- VISCA Port: 1259
- HTTPS Port: 443
- Port WebSocket: 8088

A 'Save' button is positioned at the bottom center of the configuration area.

UI Element	Description
<b>Network Ports</b>	Enter the desired port information.
<b>Save</b>	Press to save changes. Once saved, a small pop-up window will appear in the bottom right of the screen saying the changes made have been saved. <b>Note:</b> Some changes require the camera to be rebooted.

## CONFIGURATION: NETWORK CONFIGURE / ETHERNET

The screenshot shows the 'Ethernet' configuration page. On the left, a sidebar lists configuration categories: Audio, Video, Network (expanded), and System. Under 'Network', 'Ethernet' is selected. The main content area displays the following settings:

- DHCP:
- IP Address: 192.168.5.163
- Subnet Mask: 255.255.255.0
- Default Gateway: 0.0.0.0
- MAC Address: E4:77:D4:A6:62:5A

A 'Save' button is positioned at the bottom center of the configuration area.

UI Element	Description
<b>DHCP</b>	Click to enable DHCP mode; uncheck box to disable DHCP and enter Static mode.

UI Element	Description
<b>IP Address</b>	Enter the desired IP address in Static mode.
<b>Subnet Mask</b>	Enter the desired Subnet Mask in Static mode.
<b>Default Gateway</b>	Enter the desired default gateway in Static mode.
<b>MAC Address</b>	This shows the MAC address of the camera.
<b>Save</b>	Press to save changes. Once saved, a small pop-up window will appear in the bottom right of the screen saying the changes made have been saved. <b>Note:</b> Some changes require the camera to be rebooted.

## CONFIGURATION: NETWORK CONFIGURE / DNS

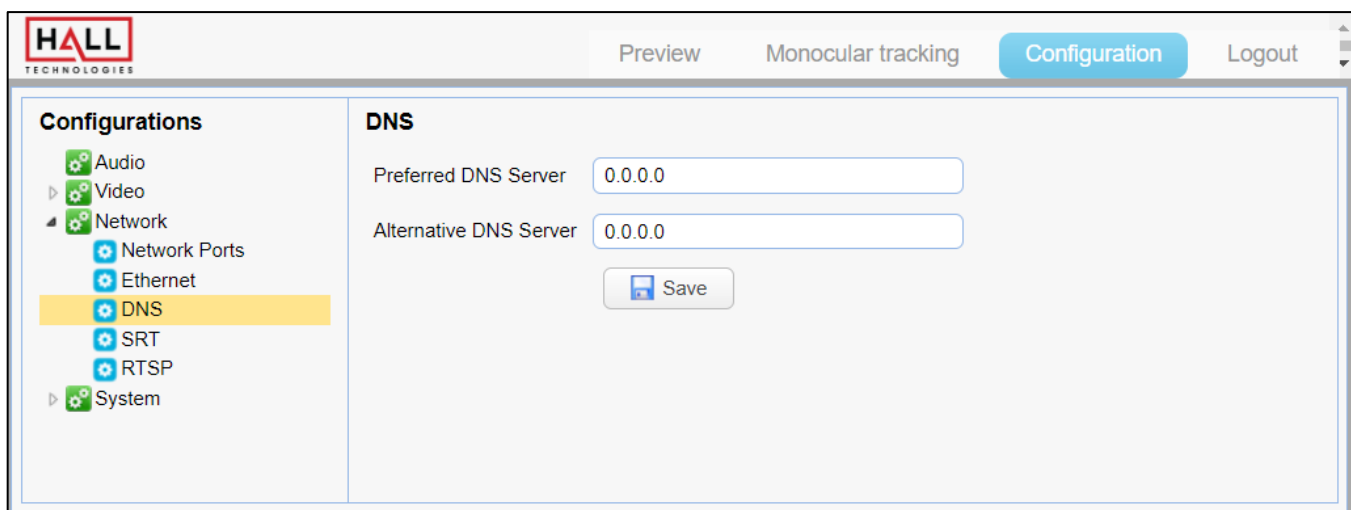

UI Element	Description
<b>Preferred DNS Server</b>	Enter the Preferred DNS Server address.
<b>Alternative DNS Server</b>	Enter the Alternative DNS Server address.
<b>Save</b>	Press to save changes. Once saved, a small pop-up window will appear in the bottom right of the screen saying the changes made have been saved. <b>Note:</b> Some changes require the camera to be rebooted.

## CONFIGURATION: NETWORK CONFIGURE / SRT

SRT (Secure Reliable Transport) is a royalty-free, open-source video streaming transport protocol that delivers secure low-latency streaming performance over noise or unpredictable (lossy) networks such as the public internet.

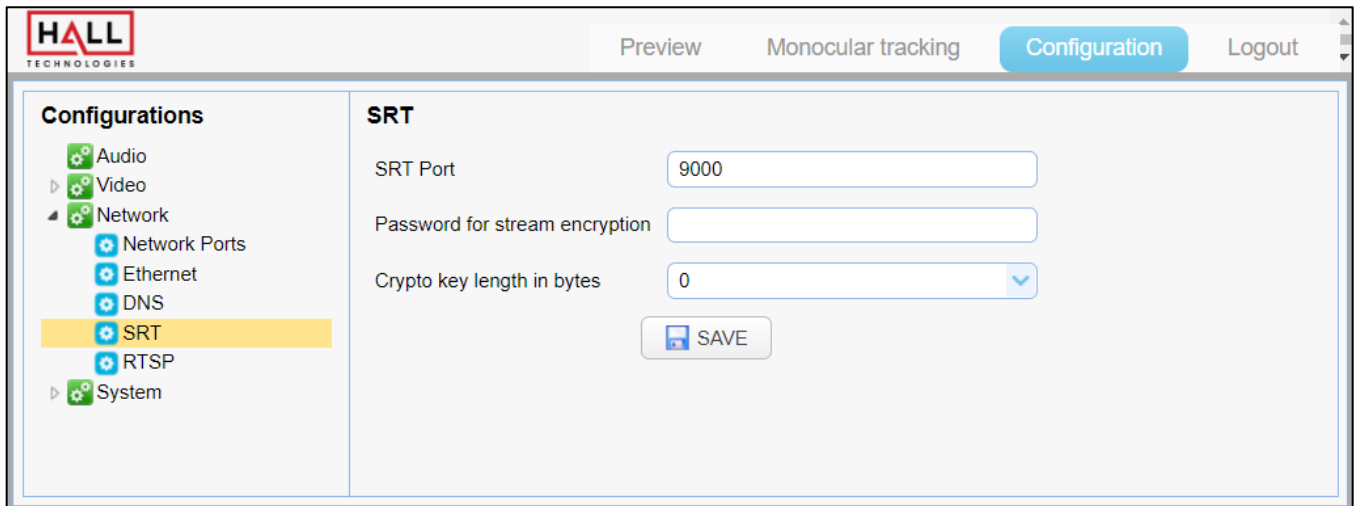

UI Element	Description
<b>Port SRT</b>	Set the desired SRT port number.
<b>Password for Stream Encryption</b>	Enter the encrypted stream password.
<b>Crypto key length in bytes</b>	Enter the crypto key length: <b>0   16   24   32</b>
<b>Save</b>	Press to save changes. Once saved, a small pop-up window will appear in the bottom right of the screen saying the changes made have been saved. <b>Note:</b> Some changes require the camera to be rebooted.

## CONFIGURATION: NETWORK CONFIGURE / RTSP

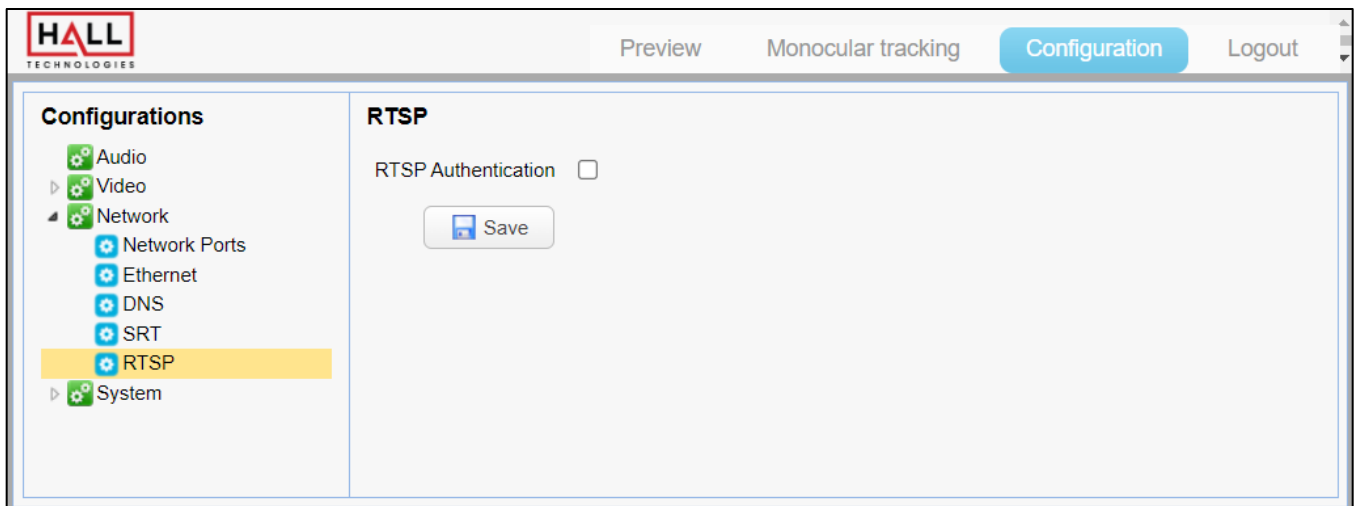

UI Element	Description
<b>RTSP Authentication</b>	Click to enable RTSP authentication.
<b>Save</b>	Press to save changes. Once saved, a small pop-up window will appear in the bottom right of the screen saying the changes made have been saved. <b>Note:</b> Some changes require the camera to be rebooted.



## CONFIGURATION: SYSTEM CONFIGURE / SYSTEM ATTRIBUTE

The screenshot displays the 'System Attribute' configuration page. On the left, a sidebar lists various configuration categories, with 'Attributes' currently selected. The main content area contains three form fields: 'Device Name' with the value 'CAMERA-1', 'Device ID' with the value '1', and 'Language' set to 'English'. A 'Save' button is positioned below these fields.

UI Element	Description
<b>Device Name</b>	Enter the desired camera name.
<b>Device ID</b>	Enter the device ID.
<b>Language</b>	Select the menu language: <b>Simplified Chinese   English</b>
<b>Save</b>	Press to save changes. Once saved, a small pop-up window will appear in the bottom right of the screen saying the changes made have been saved. <b>Note:</b> Some changes require the camera to be rebooted.

## CONFIGURATION: SYSTEM CONFIGURE / SYSTEM TIME

The screenshot shows the HALL Technologies configuration interface. The top navigation bar includes 'Preview', 'Monocular tracking', 'Configuration' (highlighted), and 'Logout'. On the left, a 'Configurations' sidebar lists 'Audio', 'Video', 'Network', 'System' (expanded), 'Attributes', 'Time' (highlighted), 'Users', 'Firmware', 'Default', and 'Reboot'. The main content area is titled 'System Time' and contains the following settings:

- Date Format: YYYY-MM-DD
- Date Separator: /
- Zone: (GMT-04:00)AST(America & Canada)
- Hour Type: 24 Hours
- NTP Enable:
- Update Interval: 1 day
- Host Url: time.nist.gov
- Host Port: 123
- Save button
- Time Settings: Synchronize with computer time
- Computer Time: 2022-12-22 08:44:41
- Sync button

UI Element	Description
<b>Date Format</b>	Select the desired format of the date: <b>YYYY-MM-DD   MM-DD-YYY   DD-MM-YYYY</b>
<b>Date Separator</b>	Select the desired date separator: .   -   /
<b>Zone</b>	Select the time zone.
<b>Hour Type</b>	Select the desired hour: <b>24 Hours   12 Hours</b>
<b>NTP Enable</b>	Click to enable NTP (Network Time Protocol)
<b>Update Interval</b>	Select how often to update the time (only available when NTP is checked)
<b>Host URL</b>	Enter the NTP host URL.
<b>Host Port</b>	Enter the host port.
<b>Save</b>	Press to save changes. Once saved, a small pop-up window will appear in the bottom right of the screen saying the changes made have been saved. <b>Note:</b> Some changes require the camera to be rebooted.
<b>Time Settings</b>	Select the time settings.
<b>Computer Time</b>	Shows the connected computer's time.
<b>Sync</b>	Sync's the selected time to the camera.

## CONFIGURATION: SYSTEM CONFIGURE / USER SET

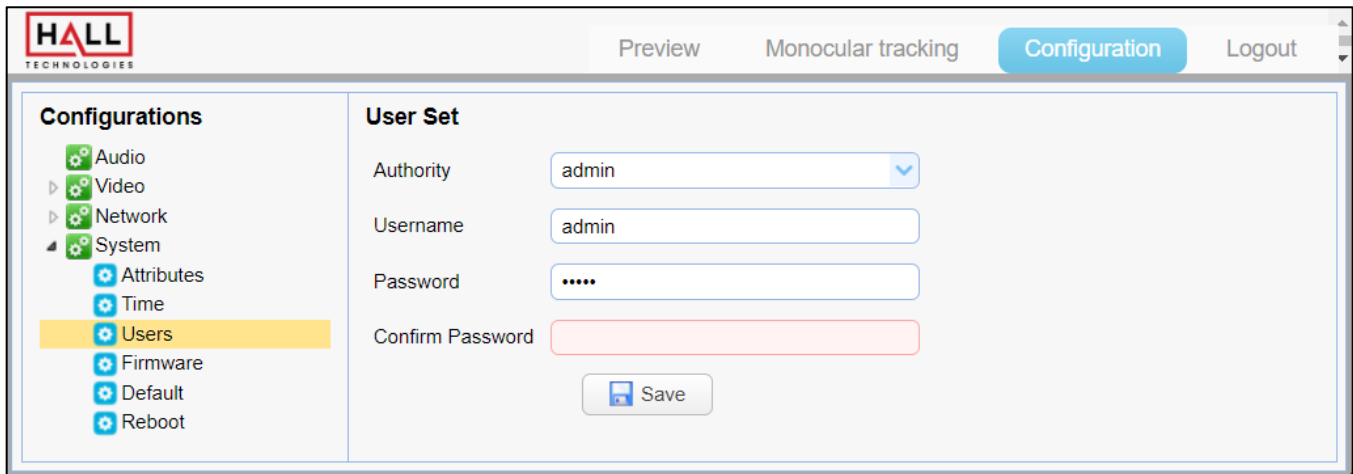

UI Element	Description
<b>Authority</b>	Select the desired user to modify
<b>Username</b>	Set the username for the selected authority
<b>Password</b>	Set the password for the selected authority
<b>Confirm Password</b>	Confirm the password
<b>Save</b>	Press to save changes. Once saved, a small pop-up window will appear in the bottom right of the screen saying the changes made have been saved. <b>Note:</b> Some changes require the camera to be rebooted.

## CONFIGURATION: SYSTEM CONFIGURE / UPDATE

This page shows the latest MCU, Camera, and AF firmware versions.

Update the firmware using the following sequence:

1. Update the **\*\*\*ARM\*\*\*.mrg** (MCU) first
2. Update the **\*\*AF\_\*\*\*.mrg** (CAM) next
3. Update the **HTML5\*\*\*.mrg** (HTML) last (if there is no HTML file then ignore this step)
4. After updating all files **restore the camera to factory default**.
5. If needed, clean all cache of the browser after performing the update.

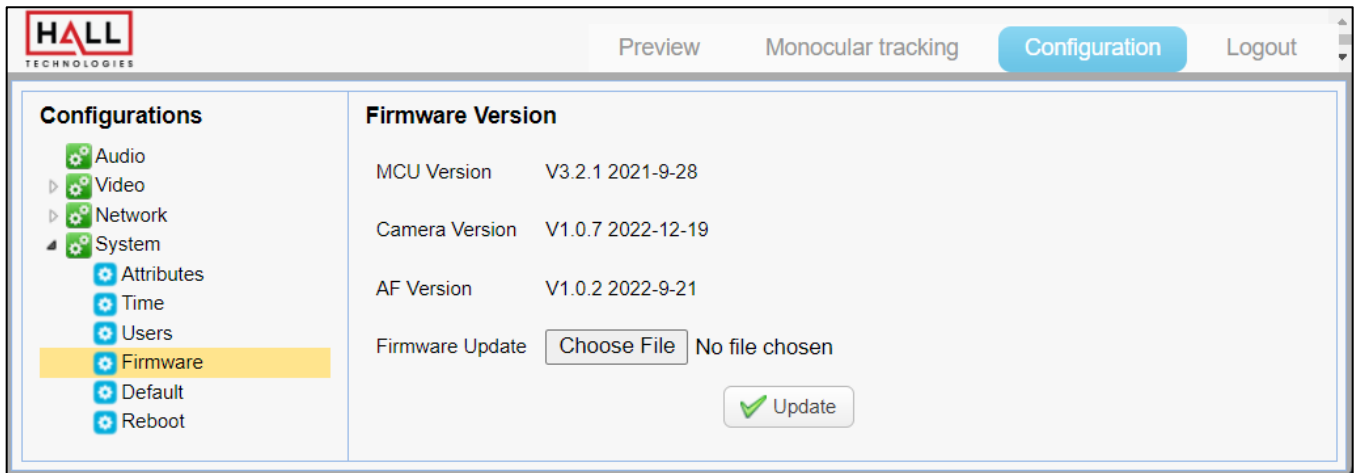

UI Element	Description
Update file	Click “Choose File” and browse for the files.
Upgrade	Click upgrade to update the firmware with the selected file. The camera will reboot after the update has been successful. <b>Note:</b> DO NOT manually power off the camera during the firmware upgrade.

## CONFIGURATION: SYSTEM CONFIGURE / DEFAULT

Click “Restore factory defaults” to return the camera’s settings to the factory defaults. A pop-up screen will ask to confirm the desire to reset the camera to the factory defaults.

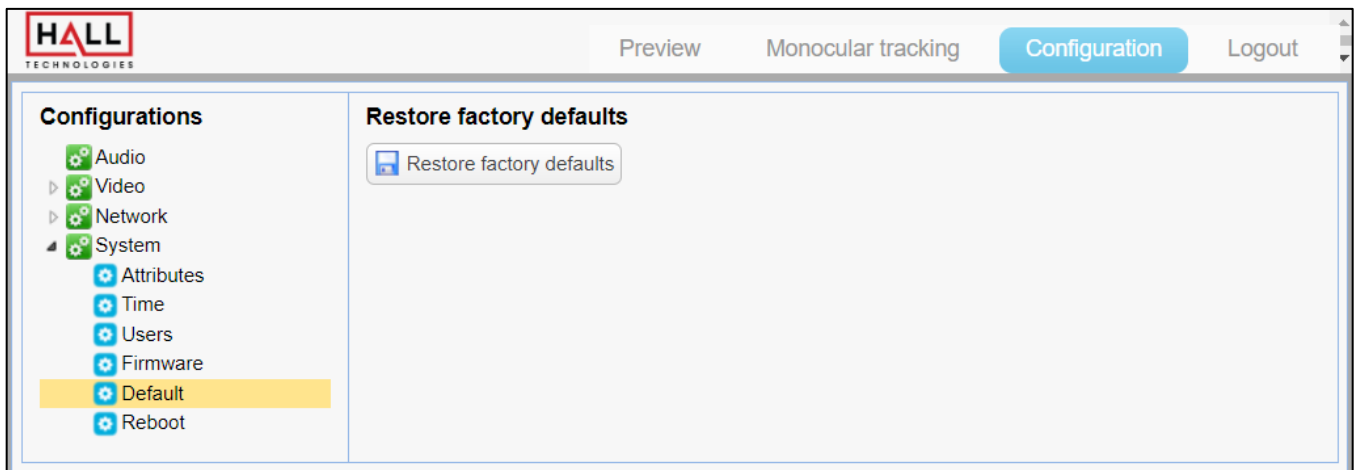

## CONFIGURATION: SYSTEM CONFIGURE / REBOOT

Click “Reboot” to reboot the camera. A pop-up screen will ask to confirm the desire to reboot the camera. After the camera reboots the user will need to login again.

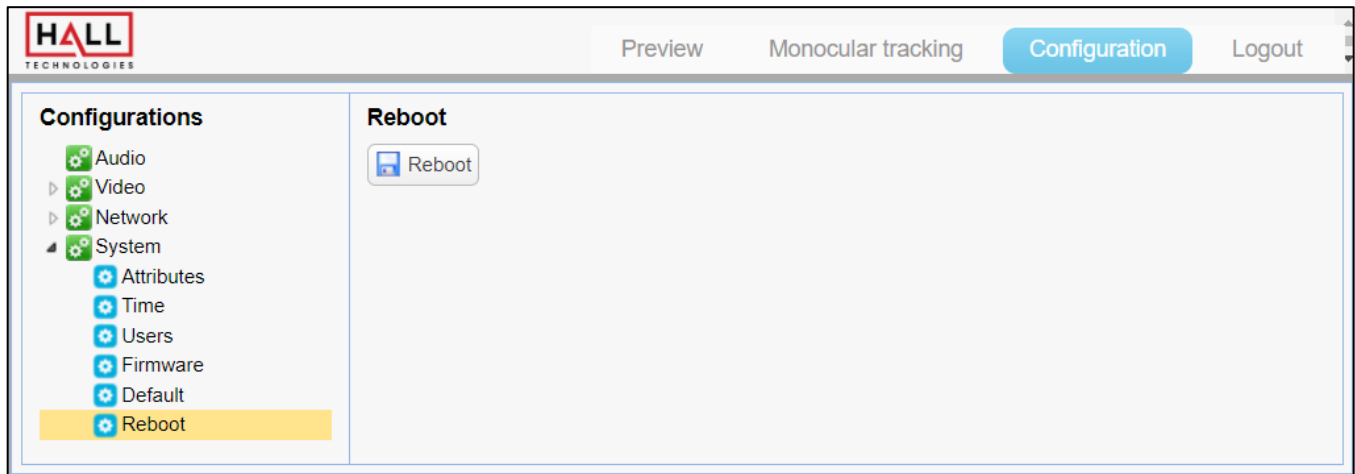

## Soft Codec Support

The following are instructions to utilizing the HT-CAM-1080PTZ camera in the Google Meet, Microsoft Teams, and Zoom soft codec applications (connecting the camera’s USB-B output to the laptop’s USB input). The HT-CAM-1080PTZ is not limited to these three. *(For soft codec applications outside of these three please refer to their user manual.)*

### GOOGLE MEET

To use the camera in Google Meet, open “More Options”, then click “Settings.” In Video Settings, select “HD Camera”.

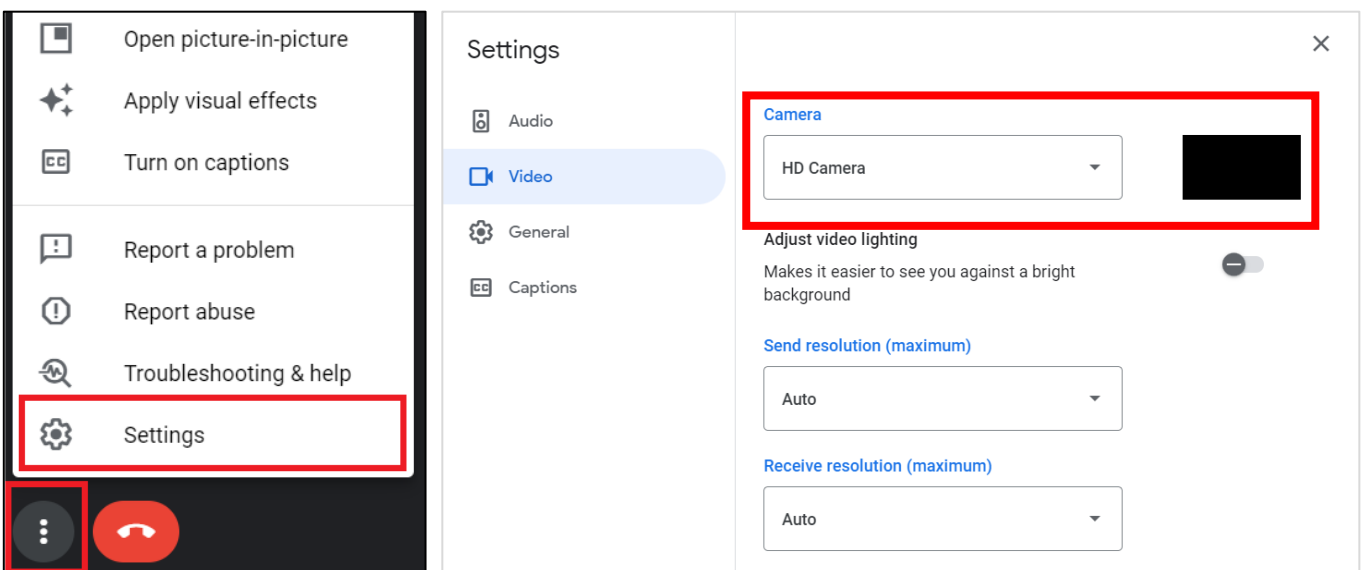

## MICROSOFT TEAMS

To use the camera in Microsoft Teams, open "Device Settings" located in the "More" menu below the **⋮** tab. In Video Settings, select the "HD-CAMERA".

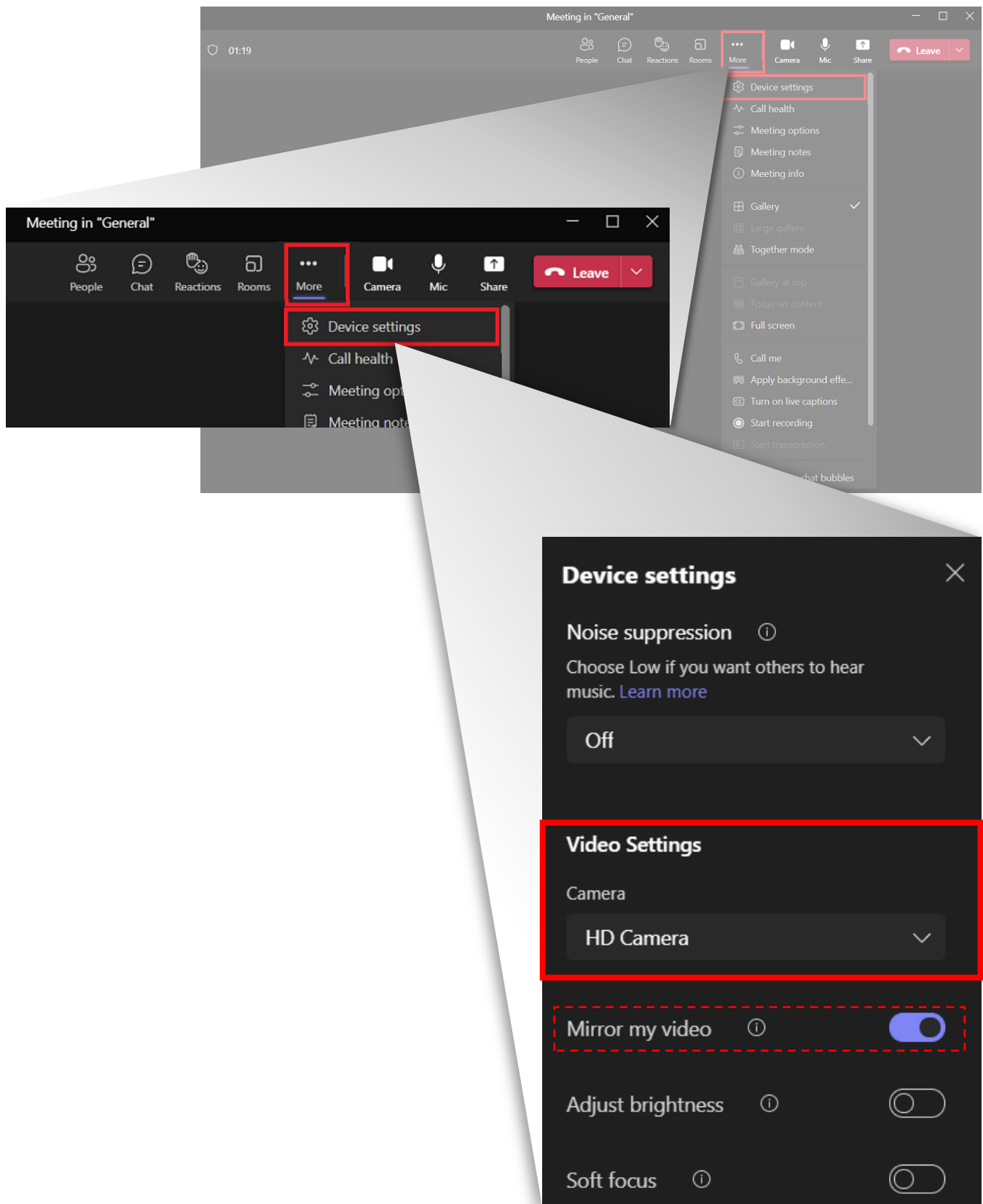

## ZOOM

To use the camera in Zoom, click on the “up” arrow on the microphone and camera buttons located on the bottom left part of the Zoom screen. In the video settings, select the “HD Camera” for the camera.

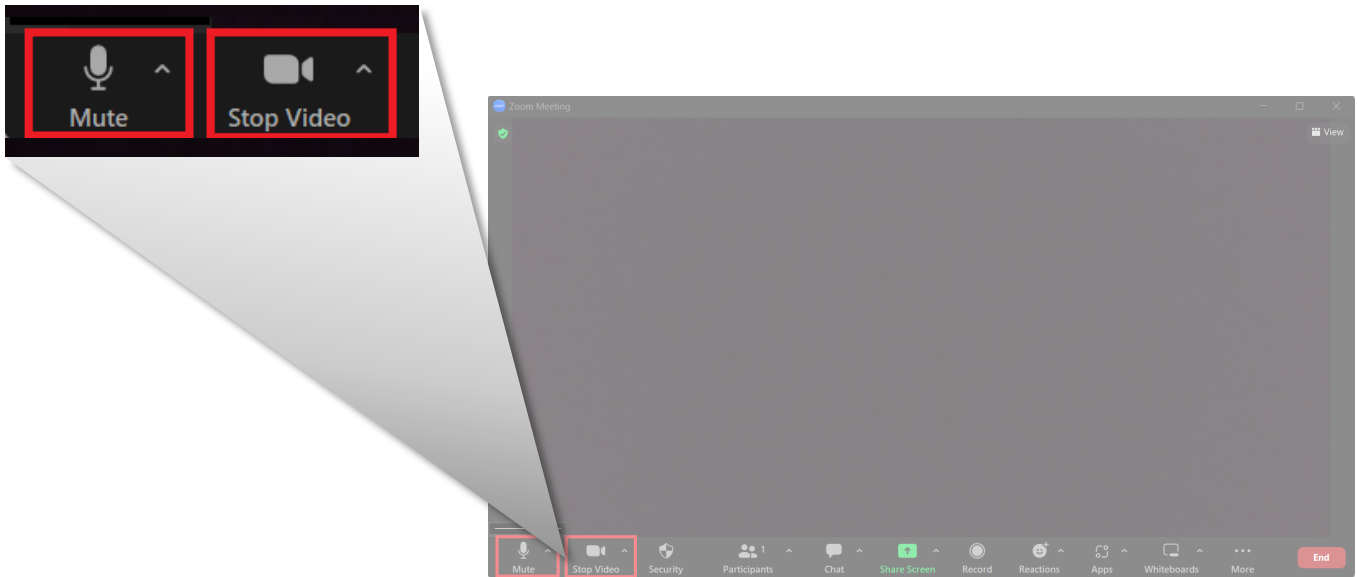

## VIDEO

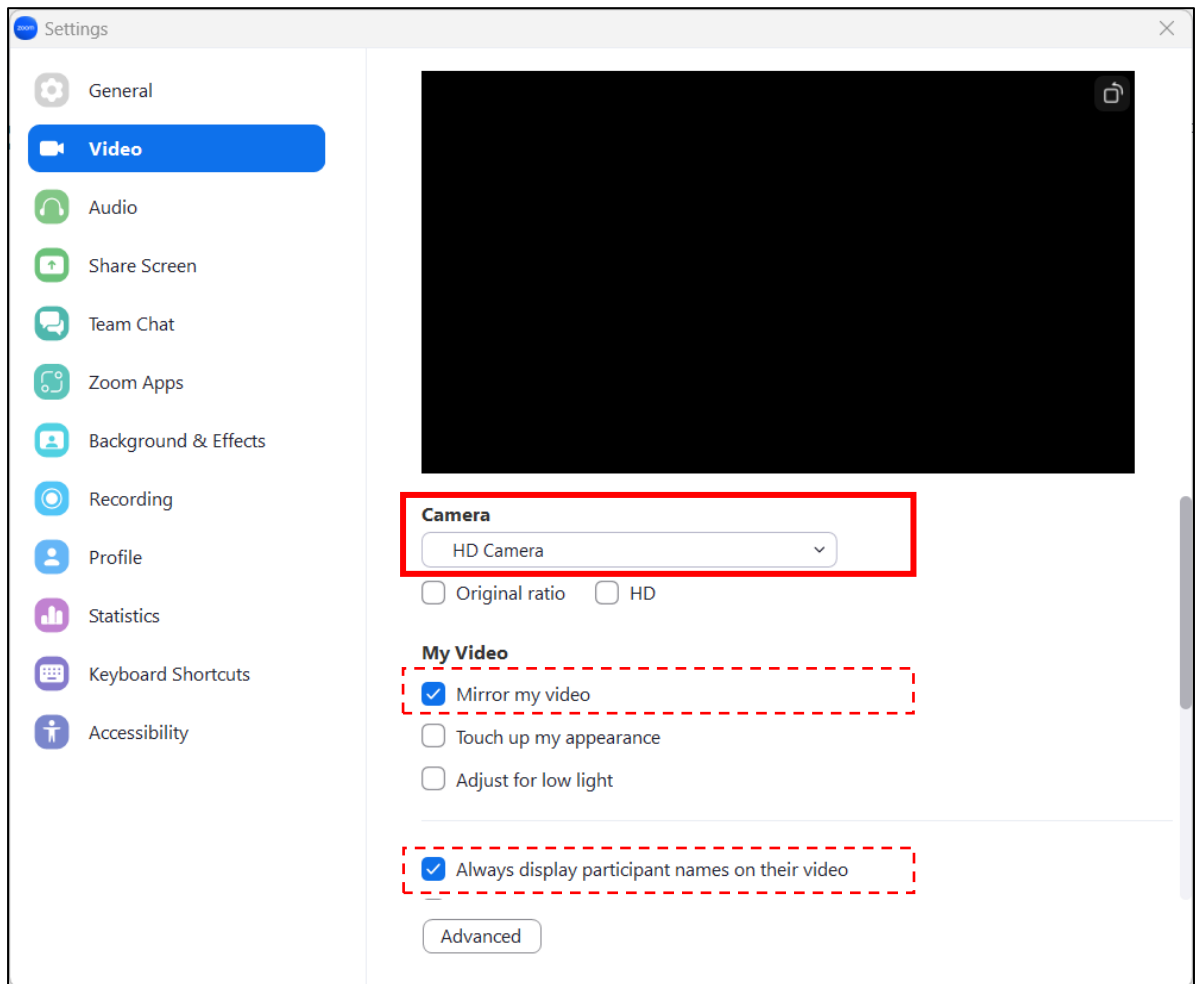

# Troubleshooting

---

## NO IMAGE

1. Verify the camera has power and the switch is turned on
  - a. Verify proper connection when powering with the included DC power supply
  - b. Verify Ethernet switch is PoE switch when powering over Ethernet and the camera's Ethernet port's lights are flashing
  - c. If properly powered the front LED will be a solid green color
2. Verify the camera can "self-test" after startup.
  - a. The camera will do a brief pan and tilt tour and then will return to the home position when starting up
3. Verify the video cable used properly connected
  - a. For HDMI:
    - i. Verify the length of the HDMI cable does not exceed HDMI's limitations (verify with HDMI cable manufacturer)
    - ii. Ensure the destination device is accessing the HDMI port the camera is connected into
  - b. For SDI:
    - i. Ensure the destination device is accessing the SDI port the camera is connected into

## ABNORMAL IMAGE

1. Check the setting of the rotary dial on the rear of the camera
  - a. If the desire is to be able to change the video format on the OSD, make sure the arrow is pointed to F.
  - b. Verify the resolution and refresh rate chosen is supported by the connected display.
2. Check the video parameters of the camera by logging into the Web UI.
  - a. Configuration -> Video -> Video Parameters
  - b. Confirm desired settings for all parameters, and if needed, perform a factory reset to return to the baseline video parameter settings

## IMAGE IS SHAKY OR VIBRATING

1. Verify the camera installation is solid and the camera is mounted to a solid surface
2. Check the building and any supporting installation hardware for vibration.
  - a. Ceiling mounts are often affected by building vibration more than wall mounts.
  - b. Any external vibration that is affecting the camera will be more apparent when the camera is zoom in on people or objects.
  - c. If the desire is to be able to change the video format on the OSD, make sure the arrow is pointed to F.



## NO VIDEO IN SOFT CODEC

1. Confirm the USB 3.0 cable is securely connected on both the camera and the PC.
2. Check the quality of the USB 3.0 cable to ensure it has not been kinked or accidentally cut.
3. Go into the soft codec application and make sure the “HD Camera” is selected as the preferred camera.
4. Try using a different application, such as the built-in camera application on the PC, to verify video can be seen there. (NOTE: if using the built-in camera application and video is shown, the camera will not be shown in any other application until that application is closed.)
5. Verify the PC has no updates pending (Windows will often disable features when new updates have been released and those features are not enabled until updates are installed.)
6. Restart the PC to verify it is operating correctly.

## Specifications

Camera	
Sensor	1/2.8-inch high quality 4K CMOS sensor
Effective Pixels	2.07MP
Video Format	HDMI/SDI: 1080p60   1080p59.94   1080p50   1080p30   1080p29.97   1080p25   720p60   720p59.94   720p50 USB3.0 Main Stream: MJPG/H.264: 1920x1080   1600x896   1280x720   1024x576   960x540   800x600   800x448   720x576   720x480   640x480   640x360   480x270   352x288   320x240 - @30/25/20/15/10/5fps YUY2/NV12: 1920x1080   1280x720   1024x576   800x600   800x448   640x480   640x360   480x270   320x180 - @30/25/20/15/10/5fps USB3.0 Sub Stream: MJPG/H.264: 1920x1080   1600x896   1280x720   1024x576   960x540   800x600   800x448   720x576   720x480   640x480   640x360   480x270   352x288   320x240 - @30/25/20/15/10/5fps YUY2/NV12: 1920x1080   1280x720   1024x576   800x600   800x448   640x480   640x360   480x270   320x180 - @30/25/20/15/10/5fps
FOV	72.5° W
Aperture	F=1.8~2.4
Optical Zoom / Digital Zoom	12X / 15X

Camera	
Minimum Illumination	0.5Lux (F1.8, AGC ON)
White Balance	Auto, manual, one-push white balance, specified color temperature
Focus	3.9~46.8mm
Focus Mode	Automatic, manual, one-push focus
Exposure Mode	Auto, manual, shutter priority, aperture priority, brightness priority
Digital Noise Reduction	2D & 3D
BLC	On / Off
Dynamic Range	Off, 1~8
Image Adjustment	Brightness, chroma, saturation, contrast, sharpness, black and white mode, gamma curve
SNR	≥50dB
Real-time Tracking	Maximum tracking range: 6~7m
Regional Tracking	Support for 4 regions within the horizontal -170°~+170° and within the vertical -30°~+90°

Video Interface	
Outputs	1x HDMI 1x SDI 1x LAN (POE) 1x USB3.0 Type-B
Video Encoding Format	LAN Interface: Supports H.264/H.265 main and sub streams USB3.0: Supports YUY2, MJPG, H.264, and NV12 main stream
Audio Interface	
Input	3.5mm Stereo Line Input
Outputs	1x HDMI 1x SDI 1x LAN 1x USB3.0 Type-B
Audio Compression	AAC, MP3, G.711A
LAN Interface	
Connection	10M/100M adaptive Ethernet port with PoE
Network Protocol	RTSP, RTMP, ONVIF, GB/T28181, VISCA over IP, IP VISCA, RTMPS, SRT
Control Interface	
Connections	1x 4-Pin Phoenix, RS232-IN, RS232-OUT, RS422 compatible with RS485

Video Interface	
Serial Communication Protocol	VISCA, Pelco-D, Pelco-P with baud rate support: 115200, 38400, 9600, 4800, 2400
USB Communication Protocol	UVC (video communication), UAC (audio communication)
Power Interface	
Connection	HEC3800 Power Socket (DC12V)
Power Adapter	Input: AC110V-AC220V Output: DC12V/2.5A
Input Voltage	DC12V±10%
Input Current	<1A
Consumption	<12W

PTZ	
Pan Rotation	-170° ~ +170°
Pan Speed	0.1°/s ~ 100°/s
Tilt Rotation	-30° ~ +90°
Tilt Speed	0.1°/s ~ 45°/s
Preset Speed	Pan: 100°/s Tilt: 45°/s
Preset Quantity	Maximum 255 preset positions (10 via remote control)

General	
Operating Temperature	-10°C to 50°C (14°F to 122°F)
Storage Temperature	-10°C to 70°C (14°F to 158°F)
Humidity	20% to 80%, non-condensing
Power Consumption	5W (Max) (5V, 1A)
Device Dimension (W x H x D)	181mm x 115mm x 149mm / 7.13" x 4.53" x 5.87"
Product Net Weight	1.15kg
Environment	Indoor



© Copyright 2022. Hall Technologies  
All rights reserved.

1234 Lakeshore Drive - Suite #150, Coppell, TX 75019  
halltechav.com / support@halltechav.com  
(714)641-6607